



www.kayalarmutfak.com.tr

Ürün Katalođu

FİYAT LİSTESİ - PRICE LIST

Catalog

2024 - 2025



kayalarofficial

Kayalar Şirketler Grubu 1957 de kurulmuştur.Kuruluş tarihinden bu yana Endüstriyel Mutfak Sektöründe faaliyet göstermekte olup yarım yüzyıllık tecrübesiyle sektörün lider kuruluşlarından biri haline gelmiştir.

Bugün 25.000 m² kapalı olmak üzere 37.000 m²'lik alanda 350'den fazla personelle Endüstriyel Mutfak cihazları imalatı, mutfak ekipmanları imalatı, tasarımı, mutfak proje ve taahhüt konuları kapsayan yaklaşık 10.000 çeşit ürün ile sektöründe öncü olmaya devam etmektedir.

Kuruluşumuz yurtiçi ve yurtdışı proje ortaklarımızla yaptığı uyumlu çalışmalarla gerek sektörün tanıtımı gerekse yeni ürünlerin tüketicilerin hizmetine sunulması ile yapılan ihracat ve ülkemize sağlanan döviz girdileriyle de üstlenmiş olduğu misyonu yerine getirmektedir. Türkiye genelinde 2 bölge müdürlüğü, 4 mağaza ve 235 adet bayiimizle hizmet vermekteyiz. Yeni katılımlar ve yatırımlarla bu hizmet ağıımızı daha da genişletmeye devam etmekteyiz.

Kalite anlayışını sadece üretim ile sınırlamayıp satış öncesi ve satış sonrası faaliyetlerimizde de yaptığımız çalışmalarla müşteri memnuniyetini esas alan ilkelerimiz doğrultusunda çalışmaktayız. Yeni teknolojilere uyumlu olarak yapılan ürünleri tüketicilere fayda sağlayacak ergonomik tasarımları, uluslar arası standartlara uygun olarak gerçekleştirmek, insan kaynaklarımıza verdiğimiz önemle müşterilerimize verdiğimiz iyi hizmetlerimize devam etmiş ve çağımızın koşulları gereği misyonumuzu en iyi şekilde devam ettirmeye kararlıyız.

Saygılarımızla,
Kayalar Şirketler Grubu

Kayalar Group of Companies was established in 1957. Since its inception, it has been operating in the Industrial Kitchen sector and, with over half a century of experience, has become one of the leading companies in the industry.

Today, with a closed area of 25,000 m² and a total area of 37,000 m², employing over 350 personnel, the company continues to lead the sector with the production of industrial kitchen equipment, kitchen appliances, design, kitchen projects, and contracting, offering approximately 10,000 different products.

The company fulfills its mission through cooperative efforts with both domestic and international project partners, contributing to the promotion of the sector, the introduction of new products to consumers, exports, and bringing foreign currency into the country. We operate with 2 regional offices, 4 stores, and 235 dealers across Turkey. We continue to expand our service network through new partnerships and investments.

We do not limit our understanding of quality to production but also focus on customer satisfaction through our pre-sales and after-sales activities. In line with our principles, we aim to provide excellent service by designing products with ergonomic features, adapting to new technologies, and ensuring they meet international standards. With the importance we place on human resources, we have continued to provide excellent services to our customers and are determined to carry out our mission in the best possible way in accordance with the conditions of our time.

Your Respectfully
Kayalar Group

index

700 SERİSİ PİŞİRİCİLER / 700 SERIES COOKERS.....	4 - 28
900 SERİSİ PİŞİRİCİLER / 900 SERIES COOKERS.....	29 - 54
SOĞUTUCULAR / COLD SYSTEMS.....	55 - 68
ÇALIŞMA TEZGAHLARI / WORK TABLES.....	69 - 81
EVYELER / SINKS.....	82 - 83
DAVLUMBAZLAR / HOODS	84 - 85
İSTİFLEME RAFLARI / STACKING SHELVES.....	86
BAR ÜNİTELERİ / BAR UNITS.....	87 - 90
AÇIK BÜFE ÜNİTELERİ / BUFFET & SERVICE UNITS.....	91 - 110
MUTFAK YARDIMCI EKİPMANLARI / KITCHEN AUXILIARY EQUIPMENTS.....	111 - 127
SERVİS EKİPMANLARI / SERVICE EQUIPMENTS.....	128 - 137
SAHRA MUTFAK / FIELD KITCHEN.....	138 - 146

* Firmamız; fiyat listesinde yer alan ürünlerle ilgili teknik özellikleri, ebat ve diğer tüm bilgileri haber vermeden değiştirme hakkına sahiptir.

* Fiyat Listesinde yer alan ve firmamızın kendi üretimi olan ürünlerimizin isim, kod no ve resimleri, firmamızın yazılı izni olmadan kopya edilemez ve kullanılamaz.

* Firmamız, önceden haber vermeden fiyat değiştirme hakkına sahiptir.

* Our company has the right to change technical specifications, size and all other information related to the products in the price list without prior notice

* Our own products name, code number and pictures cannot be copied and used without written consent

* Our company has the right to change the price without prior notice

Piřiriciler / Cookers

700 Seri / 700 Series



444 5 957
kayalarmutfak.com.tr



Ocak / Cooker



Kod / Code	: 81740321000
Model No	: KGO-4070
Boyut / Size (mm)	: 400 x 700 x 300
Güç / Power(Kw)	: 6,5 x 2 =13,00
Tüketim / Consump. (m ³ /h - Kg/h)	: 1,438 - 0,348
Hacim / Volume(m ³)	: 0,28
Ağırlık / Weight(Kg)	: 32,80
Paket Ölç./Pkg Dim(mm)	: 520 x 820 x 660
Fiyat / Price €	: 975,00 €



6,5Kw



6,5Kw



Ocak / Cooker



Kod / Code	: 81780321000
Model No	: KGO-8070
Boyut / Size (mm)	: 800 x 700 x 300
Güç / Power(Kw)	: 6,5 x 4 = 26,00
Tüketim / Consump. (m ³ /h - Kg/h)	: 2,876 - 0,696
Hacim / Volume(m ³)	: 0,50
Ağırlık / Weight(Kg)	: 60,70
Paket Ölç./Pkg Dim(mm)	: 920 x 820 x 660
Fiyat / Price €	: 1.650,00 €



6,5Kw



6,5Kw

6,5Kw

6,5Kw

TR

- * Lpg ve Doğalgaz ile çalışır.
- * Brülörler primer ve seconder yanma özelliği sayesinde yüksek yanma veriminin yanında düşük atık gaz emisyonu ile dünya standartlarında ve çevrecidir.
- * Her brülör için kazayla sönmeye karşı gaz kesme kiti içeren magnet emniyet ventilli gaz muslukları bulunur.
- * Değişik ölçülerde tencere kullanımına olanak sağlayacak şekilde tasarlanmış , ağır hizmet tipi ocak dökümleri teflon kaplıdır
- * Tek parça basılmış AISI 304 kalite paslanmaz çelik üst tabla

EN

- * Works with Lpg and Natural Gas.
- * Burners are world-class and environmentally friendly with low combustion gas emissions as well as high combustion efficiency thanks to primary and secondary burning capability.
- * Each burner has a magnet safety valve with gas shut-off kit for accidental extinguishment.
- * Heavy-duty furnace castings designed to allow the use of pots in different sizes are covered with teflon
- * Deep drawn stainless top AISI 304



Ocak / Cooker



Kod / Code	: 81740311000
Model No	: KE0-4070
Boyut / Size (mm)	: 400 x 700 x 300
Güç / Power(Kw)	: 2,25 x 2 = 4,50
Voltaj / Voltage	: 400 V
Hacim / Volume(m ³)	: 0,28
Ağırlık / Weight(Kg)	: 32,50
Paket Ölç./Pkg Dim(mm)	: 520 x 820 x 660
Fiyat / Price €	: 775,00 €



2,25Kw

2,25Kw



Ocak / Cooker



Kod / Code	: 81780311000
Model No	: KE0-8070
Boyut / Size (mm)	: 800 x 700 x 300
Güç / Power(Kw)	: 2,25 x 4 =9,00
Voltaj / Voltage	: 400 V
Hacim / Volume(m ³)	: 0,50
Ağırlık / Weight(Kg)	: 57,30
Paket Ölç./Pkg Dim(mm)	: 920 x 820 x 660
Fiyat / Price €	: 1.375,00 €



2,25Kw 2,25Kw
2,25Kw 2,25Kw

- TR** * Birbirinden bağımsız olarak ısıtıcıların her biri kademeli şalter kontrolü ile çalışmaktadır.
* Tek parça basılmış AISI 304 kalite paslanmaz çelik üst tabla
* Kullanıcıya her yönden rahatlık sağlayan ergonomik dizayna sahiptir.
* Sağlam konstrüksiyonu ile emniyetli kullanım sağlar.

- EN** * Each of the heaters can be operated separately by graded switches.
* Deep drawn stainless top AISI 304
* Ergonomical design provides comfort to the user
* Safe usage through solid construction



Ocak / Cooker



Kod / Code	: 81720321000
Model No	: KGO-12070
Boyut / Size (mm)	: 1200 x 700 x 300
Güç / Power(Kw)	: 6,5 x 6 =39,00
Tüketim / Consump. (m ³ /h - Kg/h)	: 4,314 - 1,044
Hacim / Volume(m ³)	: 0,71
Ağırlık / Weight(Kg)	: 90,50
Paket Ölç./Pkg Dim(mm)	: 1320 x 820 x 660
Fiyat / Price €	: 2.425,00 €



6,5Kw 6,5Kw 6,5Kw



Ocak / Cooker



Kod / Code	: 81720311000
Model No	: KEO-12070
Boyut / Size (mm)	: 1200 x 700 x 300
Güç / Power(Kw)	: 2,25 x 6 = 13,50
Voltaj / Voltage	: 400 V
Hacim / Volume(m ³)	: 0,71
Ağırlık / Weight(Kg)	: 87,50
Paket Ölç./Pkg Dim(mm)	: 1320 x 820 x 660
Fiyat / Price €	: 1.750,00 €



2,25Kw 2,25Kw 2,25Kw



2,25Kw 2,25Kw 2,25Kw

- TR**
- * Lpg ve Doğalgaz ile çalışır.
 - * Brülörler primer ve seconder yanma özelliği sayesinde yüksek yanma veriminin yanında düşük atık gaz emisyonu ile dünya standartlarında ve çevrecidir.
 - * Her brülör için kazayla sönmeye karşı gaz kesme kiti içeren magnet emniyet ventilli gaz muslukları bulunur.
 - * Değişik ölçülerde tencere kullanımına olanak sağlayacak şekilde tasarlanmış , ağır hizmet tipi ocak dökümleri teflon kaplıdır
 - * Tek parça basılmış AISI 304 kalite paslanmaz çelik üst tabla

- EN**
- * Works with Lpg and Natural Gas.
 - * Burners are world-class and environmentally friendly with low combustion gas emissions as well as high combustion efficiency thanks to primary and secondary burning capability.
 - * Each burner has a magnet safety valve with gas shut-off kit for accidental extinguishment.
 - * Heavy-duty furnace castings designed to allow the use of pots in different sizes are covered with teflon
 - * Deep drawn stainless top AISI 304



Kuzine Fırnı / Range with Oven



Kod / Code	: 81780820600
Model No	: KGKF - 8070
Boyut / Size (mm)	: 800 x 700 x 850
Tüketim / Consump. (m ³ /h - Kg/h)	: 3,826 - 0,896
Güç / Power(Kw)	: (6,5 x 4) + 6 = 32,00
Hacim / Volume(m ³)	: 0,91
Ağırlık / Weight(Kg)	: 121,00
Paket Ölç./Pkg Dim(mm)	: 920 x 820 x 1200
Fiyat / Price €	: 3.250,00 €



TR

- * Lpg ve Doğalgaz ile çalışır.
- * Brülörler primer ve seconder yanma özelliği sayesinde yüksek yanma veriminin yanında düşük atık gaz emisyonu ile dünya standartlarında ve çevrecidir.
- * Her brülör için kazayla sönmeye karşı gaz kesme kiti ve pilot içeren magnet emniyet ventilli gaz muslukları bulunur.
- * Değişik ölçülerde tencere kullanımına olanak sağlayacak şekilde tasarlanmış , ağır hizmet tipi ocak dökümleri teflon kaplıdır
- * tTek parça basılmış AISI 304 kalite paslanmaz çelik üst tabla
- * Derin çekme ocak tepleri üst tabladan bağımsız olup , temizliğe en hızlı ve kolay çözümü getirirken, hijyenik bir pişirme alanı sağlar
- * Fırın kapısı menteşe sistemi tek kollu olup maksimum güvenlik sağlamanın yanında iki kademeli menteşe sistemi kapı seviyelendirmesi imkanı sayesinde kullanım kolaylığı sağlar
- * Yekpare fırın gövdesi paslanmaz çelikten üretilmiştir ve fırın iç sıcaklığı magnet ventilli gaz valfi tarafından maksimum 300 °C sıcak kontrol edilebilir.
- * Fırın kısmı GN 1/1 tepsi kapasiteli ve farklı konumlarda tepsi yerleştirme özelliğine sahiptir.

EN

- * Can be operated with Lpg and Ng gas.
- * The gas burners provides a high burning fertility through primary and secondary burning and is proper to the world standart
- * Magnet ventil gas valves with flame failure device and pilot on each burner protect against gas leakage when accidental extinguishing of the flame occurs.
- * Teflon coated ,hard pan support in cast iron specially designed to provide usage of different sized pans.
- * Deep drawn stainless top AISI 304
- * Deep drawn cooking departments bring fastest and ease of cleaning, assuring hygenic cooking area
- * Two leveled oven hinge system with single arm brings maximum safety in usage plus leveling the door brings ease of usage.
- * Monoblock oven body made of stainless steel and internal oven temperature controlled by thermostatic magnet ventil gas valve with eight levels maximum 300 °C oven has GN 1/1 capacity accomodate different levels



Kuzine Fırını/Range with oven



Kod / Code	: 81780810600
Model No	: KEKF - 8070
Boyut / Size (mm)	: 800 x 700 x 850
Güç / Power(Kw)	: (2,25 x 4) + 6 =15,00
Sıcaklık / Temperature (°c)	: 50 - 300
Voltaj / Voltage	: 400 V
Hacim / Volume(m³)	: 0,91
Ağırlık / Weight(Kg)	: 120,00
Paket Ölç./Pkg Dim(mm)	: 920 x 820 x 1200
Fiyat / Price €	: 2.250,00 €



- TR** * Birbirinden bağımsız olarak ısıtıcıların her biri kademeli şalter kontrolü ile çalışmaktadır.
* Tek parça basılmış AISI 304 kalite paslanmaz çelik üst tabla
* Kullanıcıya her yönden rahatlık sağlayan ergonomik dizayna sahiptir.
* Sağlam konstrüksiyonu ile emniyetli kullanım sağlar.
* Fırın kapısı menteşe sistemi tek kollu olup maksimum güvenlik sağlamasının yanında iki kademeli menteşe sistemi kapı seviyelendirmesi imkanı sayesinde kullanım kolaylığı sağlar
* Yekpare fırın gövdesi paslanmaz çelikten üretilmiştir ve fırın iç sıcaklığı termostatik olarak 50 - 300 °C arası kontrol edilebilir.
* Fırın kısmı GN 1/1 tepsi kapasiteli ve farklı konumlarda tepsi yerleştirme özelliğine sahiptir.

- EN** * Each of to heaters can be operated separately by graded switches.
* Deep drawn stainless top AISI304
* Ergonomical design provides comfort to the user.
* Strong body construction brings safety usage.
* Two leveled oven hinge system with single arm brings maximum safety in usage plus leveling the door brings ease of usage.
* Monoblock oven body made of stainless steel and internal oven temperature controlled by thermostatically between 50 - 300 °C
* Oven has GN 1/1 Capacity and accommodate different levels.



Kuzine Fırnrlı / Range with Oven



Kod / Code	: 81720820600
Model No	: KGKF - 12070
Boyut / Size (mm)	: 1200 x 700 x 850
Tüketim / Consump. (m ³ /h - Kg/h)	: 5,429 - 1,109
Güç / Power(Kw)	: (6,5 x 6) + 6 = 45,00
Hacim / Volume(m ³)	: 1.30
Ağırlık / Weight(Kg)	: 121,00
Paket Ölç./Pkg Dim(mm)	: 1320 x 820 x 1200
Fiyat / Price €	: 4.387,00 €

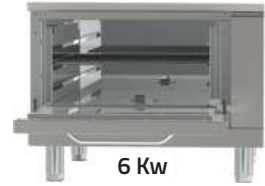
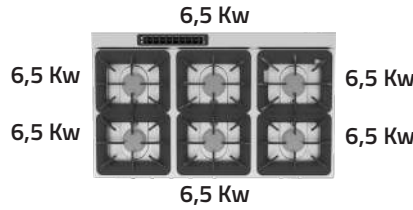

TR * Lpg ve Doğalgaz ile çalışır.

- * Brülörler primer ve seconder yanma özelliđi sayesinde yüksek yanma veriminin yanında düşük atık gaz emisyonu ile dünya standartlarında ve çevrecidir.
- * Her brülör için kazayla sönmeye karşı gaz kesme kiti ve pilot içeren magnet emniyet ventilli gaz muslukları bulunur.
- * Deđişik ölçülerde tencere kullanımına olanak sağlayacak şekilde tasarlanmış , ağır hizmet tipi ocak dökümleri teflon kaplıdır
- * Tek parça basılmış AISI 304 kalite paslanmaz çelik üst tabla
- * Derin çekme ocak tepleri üst tabladan bağımsız olup , temizliğe en hızlı ve kolay çözümü getirirken, hijyenik bir pişirme alanı sağlar
- * Fırın kapısı menteşe sistemi tek kollu olup maksimum güvenlik sağlamasının yanında iki kademeli menteşe sistemi kapı seviyelendirmesi imkanı sayesinde kullanım kolaylığı sağlar
- * Yekpare fırın gövdesi paslanmaz çelikten üretilmiştir ve fırın iç sıcaklığı magnet ventilli gaz valfi tarafından maksimum 300 °C sıcak kontrol edilebilir.
- * Fırın kısmı GN 1/1 tepsi kapasiteli ve farklı konumlarda tepsi yerleştirme özelliđine sahiptir.

EN * Can be operated with Lpg and Ng gas.

- * The gas burners provides a high burning fertility through primary and secondary burning and is proper to the world standart
- * Magnet ventil gas valves with flame failure device and pilot on each burner protect against gas leakage when accidental extinguishing of the flame occurs.
- * Teflon coated ,hard pan support in cast iron specially designed to provide usage of different sized pans.
- * Deep drawn stainless top AISI 304
- * Deep drawn cooking departments bring fastest and ease of cleaning, assuring hygenic cooking area
- * Two leveled oven hinge system with single arm brings maximum safety in usage plus leveling the door brings ease of usage.
- * Monoblock oven body made of stainless steel and internal oven temperature controlled by thermostatic magnet ventil gas valve with eight levels maximum 300 °C oven has GN 1/1 capacity accomodate different levels



Kuzine Fırnılı / Range with Oven



Kod / Code	: 81720810600
Model No	: KGKF - 12070
Boyut / Size (mm)	: 1200 x 700 x 850
Güç / Power(Kw)	: (2,25 x 6) + 6 =19,50
Voltaj / Voltage	: 400 V
Hacim / Volume(m ³)	: 1,30
Ağırlık / Weight(Kg)	: 121,00
Paket Ölç./Pkg Dim(mm)	: 1320 x 820 x 1200
Fiyat / Price €	: 3.612,50 €

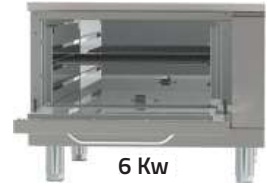
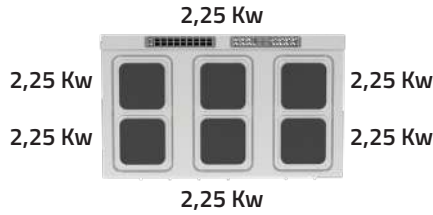

- TR** * Birbirinden bağımsız olarak ısıtıcıların her biri kademeli şalter kontrolü ile çalışmaktadır.
* Tek parça basılmış AISI 304 kalite paslanmaz çelik üst tabla
* Kullanıcıya her yönden rahatlık sağlayan ergonomik dizayna sahiptir.
* Sağlam konstrüksiyonu ile emniyetli kullanım sağlar.
* Fırın kapısı menteşe sistemi tek kollu olup maksimum güvenlik sağlamasının yanında iki kademeli menteşe sistemi kapı seviyelendirmesi imkanı sayesinde kullanım kolaylığı sağlar
* Yekpare fırın gövdesi paslanmaz çelikten üretilmiştir ve fırın iç sıcaklığı termostatik olarak 50 - 300 °C arası kontrol edilebilir.
* Fırın kısmı GN 1/1 tepsi kapasiteli ve farklı konumlarda tepsi yerleştirme özelliğine sahiptir.

- EN** * Each of to heaters can be operated separately by graded switches.
* Deep drawn stainless top AISI304
* Ergonomical design provides comfort to the user.
* Strong body construction brings safety usage.
* Two leveled oven hinge system with single arm brings maximum safety in usage plus leveling the door brings ease of usage.
* Monoblock oven body made of stainless steel and internal oven temperature controlled by thermostatically between 50 - 300 °C
* Oven has GN 1/1 Capacity and accommodate different levels.



Kuzine Fırını Tam Boy - Range With Full Size Oven ⚡

Kod / Code	: 81720810090
Model No	: KEKBE-12070
Boyut / Size (mm)	: 1200 x 700 x 850
Güç / Power(Kw)	: 19,50
Sıcaklık / Temperature (°c)	: 50-300
Voltaj / Voltage	: 400 V
Hacim / Volume(m ³)	: 1,30
Ağırlık / Weight(Kg)	: 136,00
Paket Ölç./Pkg Dim(mm)	: 1320 x 820 x 1200
Fiyat / Price €	: 3.930,00 €

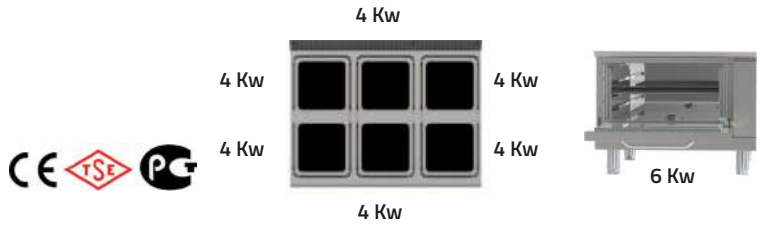

Kuzine Fırını Tam Boy - Range With Full Size Oven 🔥

Kod / Code	: 81720820090
Model No	: KGKBF - 12070
Boyut / Size (mm)	: 1200 x 700 x 850
Güç / Power(Kw)	: 45,00
Tüketim / Consump. (m ³ /h - Kg/h)	: 5,429 - 1,109
Hacim / Volume(m ³)	: 1,30
Ağırlık / Weight(Kg)	: 136,00
Paket Ölç./Pkg Dim(mm)	: 1320 x 820 x 1200
Fiyat / Price €	: 4.500,00 €

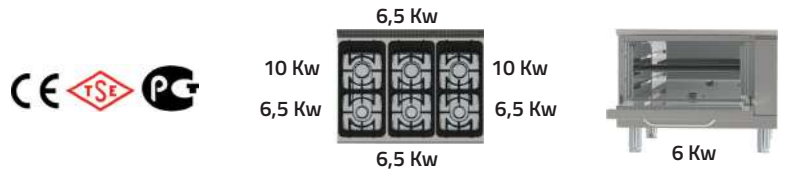

- TR** * Isıtıcılar, temizleme ve bakım kolaylığı için kaldırılabilir şekilde ve ısıyı homojen yayacak biçimde tasarlanmıştır
- * Yağ sıcaklığının maksimum 180 °C' e kadar termostatik kontrolü
- * Yağın aşırı ısınması durumunda limit termostat ısıtıcıları devre dışı bırakır ve emniyetli çalışma sağlar.
- * Uzun ömürlü, kolay temizlenebilir ve hijyeniktir.
- * Havuzdan yağın boşaltılması için önde 3/4" küresel vana
- * Maksimum güvenliği sağlamak için ; temizlik ve bakım esnasında ısıtıcı sistemi yukarıdayken , ısıtıcı enerjisini kesen sistem cihaza dahil edilmiştir.
- * Cihaz altına dolap bağlantısı yapılabilir

- EN** * Lifiable heating system with resistances designed for homogeneous heat distribution, provides easy cleaning and maintenance.
- * Thermostatic regulation of oil temperature up to a maximum of 180 °C.
- * In case of over heating of the oil , limit thermostat stops the heating elements and provides safety operate.
- * Long life, easy cleaning, and hygienic due to its stainless steel construction.
- * Spherical valve to drain oil from the container included on the front side
- * Safety system shutting off energy of the heaters included, to provide maximum safety through maintenance and cleaning while heat system lifted up



Fritöz/Deep Fryer



Kod / Code	: 81740312000
Model No	: KEF - 4070
Boyut / Size (mm)	: 400 x 700 x 300
Güç / Power(Kw)	: 10,50
Sıcaklık / Temperature (°c)	: 100 - 190
Voltaj / Voltage	: 400 V
Kapasite / Capacity (Lt)	: 15,00
Hacim / Volume(m ³)	: 0,28
Ağırlık / Weight(Kg)	: 30,50
Paket Ölç./Pkg Dim(mm)	: 520 x 820 x 660
Fiyat / Price €	: 1.250,00 €



Fritöz/Deep Fryer



Kod / Code	: 81780312000
Model No	: KEF - 8070
Boyut / Size (mm)	: 800 x 700 x 300
Güç / Power(Kw)	: 10,5 + 10,5 = 21,00
Sıcaklık / Temperature (°c)	: 100 - 190
Voltaj / Voltage	: 400 V
Kapasite / Capacity (Lt)	: 15 + 15
Hacim / Volume(m ³)	: 0,50
Ağırlık / Weight(Kg)	: 56,00
Paket Ölç./Pkg Dim(mm)	: 920 x 820 x 660
Fiyat / Price €	: 2.250,00 €



- TR** * Isıtıcılar, temizleme ve bakım kolaylığı için kaldırılabilir şekilde ve ısıyı homojen yayacak biçimde tasarlanmıştır
* Yağ sıcaklığının maksimum 180 °C' e kadar termostatik kontrolü
* Yağın aşırı ısınması durumunda limit termostat ısıtıcıları devre dışı bırakır ve emniyetli çalışma sağlar.
* Uzun ömürlü, kolay temizlenebilir ve hijyeniktir.
* Havuzdan yağın boşaltılması için önde 3/4" küresel vana
* Maksimum güvenliği sağlamak için ; temizlik ve bakım esnasında ısıtıcı sistemi yukarıdayken , ısıtıcı enerjisini kesen sistem cihaza dahil edilmiştir.
* Cihaz altına dolap bağlantısı yapılabilir

- EN** * Lifiable heating system with resistances designed for homogeneous heat distribution, provides easy cleaning and maintenance.
* Thermostatic regulation of oil temperature up to a maximum of 180 °C.
* In case of over heating of the oil , limit thermostat stops the heating elements and provides safety operate.
* Long life, easy cleaning, and hygienic due to its stainless steel construction.
* Spherical valve to drain oil from the container included on the front side
* Safety system shutting off energy of the heaters included, to provide maximum safety through maintenance and cleaning while heat system lifted up



Fritöz/Deep Fryer



Kod / Code	: 81740822000
Model No	: KGFD - 4070
Boyut / Size (mm)	: 400 x 740 x 850
Güç / Power(Kw)	: 14,00
Sıcaklık / Temperature (° c)	: 100 - 190
Tüketim / Consump. (m ³ /h - Kg/h)	: 1,805 - 0,540
Kapasite / Capacity (Lt)	: 20,00
Hacim / Volume(m ³)	: 0,58
Ağırlık / Weight(Kg)	: 64,00
Paket Ölç./Pkg Dim(mm)	: 520 x 820 x 1350
Fiyat / Price €	: 1.975,00 €



Fritöz/Deep Fryer



Kod / Code	: 81780822000
Model No	: KGFD - 8070
Boyut / Size (mm)	: 800 x 700 x 850
Güç / Power(Kw)	: 14 + 14 = 28,00
Sıcaklık / Temperature (° c)	: 100 - 190
Tüketim / Consump. (m ³ /h - Kg/h)	: 3,700 - 1,080
Kapasite / Capacity (Lt)	: 20 + 20
Hacim / Volume(m ³)	: 1,00
Ağırlık / Weight(Kg)	: 106,00
Paket Ölç./Pkg Dim(mm)	: 920 x 820 x 1350
Fiyat / Price €	: 3.625,00 €



- TR** * Lpg ve Doğalgaz ile çalışır.ısıtıcılar, temizleme ve bakım kolaylığı için kaldırılabilir şekilde ve ısıyı homojen yayacak biçimde tasarlanmıştır
- * Yağ sıcaklığının maksimum 180 °C' e kadar termostatik kontrolü
- * Yağın aşırı ısınması durumunda limit termostat ısıtıcıları devre dışı bırakır ve emniyetli çalışma sağlar.
- * Uzun ömürlü, kolay temizlenebilir ve hijyeniktir.
- * Havuzdan yağın boşaltılması için 3/4" küresel vana Maksimum güvenliği sağlamak için ; temizlik ve bakım esnasında ısıtıcı sistemi yukarıdayken , ısıtıcı enerjisini kesen sistem cihaza dahil edilmiştir.
- * Dolapların kapı yönü değişebilir

- EN** * Can be operated with LPG and NG Gas
- * Lifiable heating system with resistances designed for homogeneous heat distribution, provides easy cleaning and maintenance
- * Thermostatic regulation of oil temperature up to a maximum of 180 °C
- * In case of over heating of the oil, limit thermostat stops the heating elements and provides safety operate.
- * Long life, easy cleaning and hygienic due to its
- * Spherical valve to drain oil from the container
- * Safety system shutting off energy of the heaters



Izgara Düz / Grill Smooth



Kod / Code	: 81720323010
Model No	: KGDI - 12070
Boyut / Size (mm)	: 1200 x 700 x 300
Güç / Power(Kw)	: 22,80
Tüketim / Consump. (m ³ /h - Kg/h)	: 2,196 - 0,687
Hacim / Volume(m ³)	: 0,84
Ağırlık / Weight(Kg)	: 167,00
Paket Ölç./Pkg Dim(mm)	: 1320 x 820 x 770
Fiyat / Price €	: 2.500,00 €



Chrome Surface 800 €



Izgara Oluklu / Grill Ribbed



Kod / Code	: 81720323020
Model No	: KGDI - 12070
Boyut / Size (mm)	: 1200 x 700 x 300
Güç / Power(Kw)	: 22,80
Tüketim / Consump. (m ³ /h - Kg/h)	: 2,196 - 0,687
Hacim / Volume(m ³)	: 0,84
Ağırlık / Weight(Kg)	: 167,00
Paket Ölç./Pkg Dim(mm)	: 1320 x 820 x 770
Fiyat / Price €	: 2.875,00 €



Chrome Surface 800 €

- TR** * Lpg ve Doğalgaz ile çalışır.
* Her brülör için kazayla sönmeye karşı gaz kesme kiti ve pilot içeren magnet emniyet ventilli gaz muslukları bulunur.
* Kızartma yüzeyi önünde yağ toplama kanalı ve tahliyesi mevcuttur.
* Kızartma sırasında süzülen yağların biriktiği yağ çekmecesi vardır.
* Kontrol panelinde pilot alevini kontrol etmek için açıklık bulunur
* Cihaz altına dolap bağlantısı yapılabilir

- EN** * Can be operated with Lpg and Ng gas.
* Magnet ventil gas valves with flame failure device and pilot on each burner protect against gas leakage when accidental extinguishing of the flame occurs.
* Oil canal and drain hole take place on the front side of the grill surface
* Collecting drawer for the straining oil.
* An opening takes place on the control panel to check the pilot flame situation
* Unit to be mounted on open base cupboards



Izgara Yarıoluklu / 1/2 Grill Ribbed



Kod / Code	: 81720323030
Model No	: KGDI - 12070
Boyut / Size (mm)	: 1200 x 700 x 300
Güç / Power(Kw)	: 22,80
Tüketim / Consump. (m ³ /h - Kg/h)	: 2,196 - 0,687
Hacim / Volume(m ³)	: 0,84
Ağırlık / Weight(Kg)	: 167,00
Paket Ölç./Pkg Dim(mm)	: 1320 x 820 x 770
Fiyat / Price €	: 2,750,00 €



Chrome Surface 800 €

- TR** * Lpg ve Doğalgaz ile çalışır.
* Her brülör için kazayla sönmeye karşı gaz kesme kiti ve pilot içeren magnet emniyet ventilli gaz muslukları bulunur.
* Kızartma yüzeyi önünde yağ toplama kanalı ve tahliyesi mevcuttur.
* Kızartma sırasında süzölen yağların biriktiği yağ çekmecesi vardır.
* Kontrol panelinde pilot alevini kontrol etmek için açıklık bulunur
* Cihaz altına dolap bağlantısı yapılabilir

- EN** * Can be operated with Lpg and Ng gas.
* Magnet ventill gas valves with flame failure device and pilot on each burner protect against gas leakage when accidental extinguishing of the flame occurs.
* Oil canal and drain hole take place on the front side of the grill surface
* Collecting drawer for the straining oil.
* An opening takes place on the control panel to check the pilot flame situation
* Unit to be mounted on open base cupboards



Chrome Surface 350 €

Izgara Düz / Grill Smooth



Kod / Code	: 81740323010
Model No	: KGDI - 4070
Boyut / Size (mm)	: 400 x 700 x 300
Güç / Power(Kw)	: 7,80
Tüketim / Consump. (m ³ /h - Kg/h)	: 0,759 - 0,241
Hacim / Volume(m ³)	: 0,33
Ağırlık / Weight(Kg)	: 55,40
Paket Ölç./Pkg Dim(mm)	: 520 x 320 x 770
Fiyat / Price €	: 1.125,00 €



Chrome Surface 600 €

Izgara Düz / Grill Smooth



Kod / Code	: 81780323010
Model No	: KGDI - 8070
Boyut / Size (mm)	: 800 x 700 x 300
Güç / Power(Kw)	: 15,20
Tüketim / Consump. (m ³ /h - Kg/h)	: 1,464 - 0,458
Hacim / Volume(m ³)	: 0,59
Ağırlık / Weight(Kg)	: 100,00
Paket Ölç./Pkg Dim(mm)	: 920 x 820 x 770
Fiyat / Price €	: 1.750,00 €



- TR** * Lpg ve Doğalgaz ile çalışır.
* Her brülör için kazayla sönmeye karşı gaz kesme kiti ve pilot içeren magnet emniyet ventilli gaz muslukları bulunur.
* Kızartma yüzeyi önünde yağ toplama kanalı ve tahliyesi mevcuttur.
* Kızartma sırasında süzölen yağların biriktiği yağ çekmecesi vardır.
* Kontrol panelinde pilot alevini kontrol etmek için açıklık bulunur
* Cihaz altına dolap bağlantısı yapılabilir

- EN** * Can be operated with Lpg and Ng gas.
* Magnet ventil gas valves with flame failure device and pilot on each burner protect against gas leakage when accidental extinguishing of the flame occurs.
* Oil canal and drain hole take place on the front side of the grill surface
* Collecting drawer for the straining oil.
* An opening takes place on the control panel to check the pilot flame situation
* Unit to be mounted on open base cupboards

700 Seri / Series



Chrome Surface 350 €

Izgara Oluklu / Grill Ribbed



Kod / Code	: 81740323020
Model No	: KGOI - 4070
Boyut / Size (mm)	: 400 x 700 x 300
Güç / Power(Kw)	: 7,80
Tüketim / Consump. (m ³ /h - Kg/h)	: 0,759 - 0,241
Hacim / Volume(m ³)	: 0,33
Ağırlık / Weight(Kg)	: 55,40
Paket Ölç./Pkg Dim(mm)	: 520 x 820 x 770
Fiyat / Price €	: 1.200,00 €



Chrome Surface 600 €

Izgara Oluklu / Grill Ribbed



Kod / Code	: 81780323020
Model No	: KGOI - 8070
Boyut / Size (mm)	: 800 x 700 x 300
Güç / Power(Kw)	: 15,20
Tüketim / Consump. (m ³ /h - Kg/h)	: 1,464 - 0,458
Hacim / Volume(m ³)	: 0,59
Ağırlık / Weight(Kg)	: 100,00
Paket Ölç./Pkg Dim(mm)	: 920 x 820 x 770
Fiyat / Price €	: 1.950,00 €



- TR** * Lpg ve Doğalgaz ile çalışır.
* Her brülör için kazayla sönmeye karşı gaz kesme kiti ve pilot içeren magnet emniyet ventilli gaz muslukları bulunur.
* Kızartma yüzeyi önünde yağ toplama kanalı ve tahliyesi mevcuttur.
* Kızartma sırasında süzölen yağların biriktiği yağ çekmecesi vardır.
* Kontrol panelinde pilot alevini kontrol etmek için açıklık bulunur
* Cihaz altına dolap bağlantısı yapılabilir

- EN** * Can be operated with Lpg and Ng gas.
* Magnet ventil gas valves with flame failure device and pilot on each burner protect against gas leakage when accidental extinguishing of the flame occurs.
* Oil canal and drain hole take place on the front side of the grill surface
* Collecting drawer for the straining oil.
* An opening takes place on the control panel to check the pilot flame situation
* Unit to be mounted on open base cupboards



Izgara 1/2 Oluklu / 1/2 Grill Ribbed



Kod / Code	: 81780323030
Model No	: KGYI - 8070
Boyut / Size (mm)	: 800 x 700 x 300
Güç / Power(Kw)	: 15,20
Tüketim / Consump. (m ³ /h - Kg/h)	: 1,464 - 0,458
Hacim / Volume(m ³)	: 0,59
Ağırlık / Weight(Kg)	: 100,90
Paket Ölç./Pkg Dim(mm)	: 920 x 820 x 770
Fiyat / Price €	: 1.900,00 €

Chrome Surface 600 €



Izgara 1/2 Oluklu / 1/2 Grill Ribbed



Kod / Code	: 81780313030
Model No	: KEYI - 8070
Boyut / Size (mm)	: 800 x 700 x 300
Güç / Power(Kw)	: 9,60
Sıcaklık / Temperature (°c)	: 50 - 300
Voltaj / Voltage	: 400 V
Hacim / Volume(m ³)	: 0,50
Ağırlık / Weight(Kg)	: 95,00
Paket Ölç./Pkg Dim(mm)	: 920 x 820 x 660
Fiyat / Price €	: 1.600,00 €

Chrome Surface 450 €



- TR** * Kızartma yüzeyi önünde yağ toplama kanalı ve tahliyesi
* Kızartma sırasında süzülen yağların biriktiği yağ çekmecesi mevcuttur.
* 50-300 °C arası termostatik sıcaklık kontrolü.
* Uzun ömürlü, kolay temizlenebilir ve hijyeniktir.
* Cihaz altına dolap bağlantısı yapılabilir

- EN** * Oil canal and drain hole take place on the front side of the grill surface
* Collecting drawer for the straining oil.
* Thermostatic regulation of temperature between 50-300 °C.
* Long life, easy cleaning, and hygienic due to its stainless steel construction.
* Unit to be mounted on open base cupboards



Chrome Surface 250 €

Izgara Düz / Grill Smooth



Kod / Code	: 81740313010
Model No	: KEDI - 4070
Boyut / Size (mm)	: 400 x 700 x 300
Güç / Power(Kw)	: 3,20
Sıcaklık / Temperature (°c)	: 50 - 300
Voltaj / Voltage	: 400 V
Hacim / Volume(m ³)	: 0,28
Ağırlık / Weight(Kg)	: 46,00
Paket Ölç./Pkg Dim(mm)	: 520 x 820 x 660
Fiyat / Price €	: 1.000,00 €



Chrome Surface 450 €

Izgara Düz / Grill Smooth



Kod / Code	: 81780313010
Model No	: KEDI - 8070
Boyut / Size (mm)	: 800 x 700 x 300
Güç / Power(Kw)	: 9,60
Sıcaklık / Temperature (°c)	: 50 - 300
Voltaj / Voltage	: 400 V
Hacim / Volume(m ³)	: 0,50
Ağırlık / Weight(Kg)	: 95,00
Paket Ölç./Pkg Dim(mm)	: 920 x 820 x 660
Fiyat / Price €	: 1.600,00 €



- TR** * Kızartma yüzeyi önünde yağ toplama kanalı ve tahliyesi
* Kızartma sırasında süzölen yağların biriktiği yağ çekmecesi mevcuttur.
*50-300 °C arası termostatik sıcaklık kontrolü.
*Uzun ömürlü, kolay temizlenebilir ve hijyeniktir.
*Cihaz altına dolap bağlantısı yapılabilir

- EN** * Oil canal and drain hole take place on the front side of the grill surface
* Collecting drawer for the straining oil.
* Thermostatic regulation of temperature between 50-300 °C.
* Long life, easy cleaning, and hygienic due to its stainless steel construction.
* Unit to be mounted on open base cupboards



Chrome Surface 250 €

Izgara Oluklu / Grill Ribbed



Kod / Code	: 81740313020
Model No	: KE01 - 4070
Boyut / Size (mm)	: 400 x 700 x 300
Güç / Power(Kw)	: 3,20
Sıcaklık / Temperature (°c)	: 50 - 300
Voltaj / Voltage	: 400 V
Hacim / Volume(m ³)	: 0,28
Ağırlık / Weight(Kg)	: 46,00
Paket Ölç./Pkg Dim(mm)	: 520 x 820 x 660
Fiyat / Price €	: 1.100,00 €



Chrome Surface 450 €

Izgara Oluklu / Grill Ribbed



Kod / Code	: 81780313020
Model No	: KE01 - 8070
Boyut / Size (mm)	: 800 x 700 x 300
Güç / Power(Kw)	: 9,60
Sıcaklık / Temperature (°c)	: 50 - 300
Voltaj / Voltage	: 400 V
Hacim / Volume(m ³)	: 0,50
Ağırlık / Weight(Kg)	: 95,00
Paket Ölç./Pkg Dim(mm)	: 920 x 820 x 660
Fiyat / Price €	: 1.700,00 €



- TR** * Kızartma yüzeyi önünde yağ toplama kanalı ve tahliyesi
* Kızartma sırasında süzölen yağların biriktiđi yağ çekmecesi mevcuttur.
* 50-300 °C arası termostatik sıcaklık kontrolü.
* Uzun ömürlü, kolay temizlenebilir ve hijyeniktir.
* Cihaz altına dolap bağlantısı yapılabilir

- EN** * Oil canal and drain hole take place on the front side of the grill surface
* Collecting drawer for the straining oil.
* Thermostatic regulation of temperature between 50-300 °C.
* Long life, easy cleaning, and hygienic due to its stainless steel construction.
* Unit to be mounted on open base cupboards



Izgara Lavatař / Lavastone Grill



Kod / Code	: 81720340000
Model No	: KGLI - 12070
Boyut / Size (mm)	: 1200 x 700 x 300
Güç / Power(Kw)	: 21,00
Tüketim / Consump. (m ³ /h - Kg/h)	: 2,724 - 0,873
Hacim / Volume(m ³)	: 0,71
Ağırlık / Weight(Kg)	: 110,00
Paket Ölç./Pkg Dim(mm)	: 1320 x 820 x 660
Fiyat / Price €	: 3.000,00 €



Izgara Sulu Döküm / Lavastone Water Grill



Kod / Code	: 81720325000
Model No	: KGSİ - 8070
Boyut / Size (mm)	: 1200 x 700 x 300
Güç / Power(Kw)	: 21,00
Tüketim / Consump. (m ³ /h - Kg/h)	: 2,724 - 0,873
Hacim / Volume(m ³)	: 0,71
Ağırlık / Weight(Kg)	: 110,00
Paket Ölç./Pkg Dim(mm)	: 1320 x 820 x 660
Fiyat / Price €	: 3.250,00 €



- TR** * Lpg ve Doğalgaz ile çalışır.
* Her brülör için kazayla sönmeye karşı gaz kesme kiti ve pilot içeren magnet emniyet ventilli gaz muslukları bulunur.
* Kızartma yüzeyi önünde yağ toplama kanalı ve tahliyesi mevcuttur.
* Kızartma sırasında süzölen yağların biriktiği yağ çekmecesi vardır.
* Kontrol panelinde pilot alevini kontrol etmek için açıklık bulunur
* Cihaz altına dolap bağlantısı yapılabilir

- EN** * Can be operated with Lpg and Ng gas.
* Magnet ventil gas valves with flame failure device and pilot on each burner protect against gas leakage when accidental extinguishing of the flame occurs.
* Oil canal and drain hole take place on the front side of the grill surface
* Collecting drawer for the straining oil.
* An opening takes place on the control panel to check the pilot flame situation
* Unit to be mounted on open base cupboards



Izgara Lavatař / Lavastone Grill



Kod / Code	: 81740324000
Model No	: KGLI - 4070
Boyut / Size (mm)	: 400 x 700 x 300
Güç / Power(Kw)	: 7,00
Tüketim / Consump. (m ³ /h - Kg/h)	: 0,908 - 0,291
Hacim / Volume(m ³)	: 0,28
Ağırlık / Weight(Kg)	: 54,00
Paket Ölç./Pkg Dim(mm)	: 520 x 820 x 660
Fiyat / Price €	: 1.550,50 €



Izgara Lavatař / Lavastone Grill



Kod / Code	: 81780324000
Model No	: KGLI - 8070
Boyut / Size (mm)	: 800 x 700 x 300
Güç / Power(Kw)	: 14,00
Tüketim / Consump. (m ³ /h - Kg/h)	: 1,816 - 0,583
Hacim / Volume(m ³)	: 0,50
Ağırlık / Weight(Kg)	: 96,00
Paket Ölç./Pkg Dim(mm)	: 920 x 820 x 660
Fiyat / Price €	: 2.225,00 €



- TR** * Lpg ve Doğalgaz ile çalışır.
* Her brülör için kazayla sönmeye karşı gaz kesme kiti ve pilot içeren magnet emniyet ventilli gaz muslukları bulunur.
* Kızartma yüzeyi önünde yağ toplama kanalı ve tahliyesi mevcuttur.
* Kızartma sırasında süzölen yağların biriktiği yağ çekmecesini vardır.
* Kontrol panelinde pilot alevini kontrol etmek için açıklık bulunur
* Cihaz altına dolap bağlantısı yapılabilir

- EN** * Can be operated with Lpg and Ng gas.
* Magnet ventil gas valves with flame failure device and pilot on each burner protect against gas leakage when accidental extinguishing of the flame occurs.
* Oil canal and drain hole take place on the front side of the grill surface
* Collecting drawer for the straining oil.
* An opening takes place on the control panel to check the pilot flame situation
* Unit to be mounted on open base cupboards



Izgara Sulu Döküm / Lavastone Water Grill



Kod / Code	: 81740325000
Model No	: KGSİ-4070
Boyut / Size (mm)	: 400 x 700 x 300
Güç / Power(Kw)	: 7,00
Tüketim / Consump. (m ³ /h - Kg/h)	: 0,908 - 0,291
Hacim / Volume(m ³)	: 0,28
Ağırlık / Weight(Kg)	: 52,00
Paket Ölç./Pkg Dim(mm)	: 520 x 820 x 660
Fiyat / Price €	: 1.625,00 €



Izgara Sulu Döküm / Lavastone Water Grill



Kod / Code	: 81780325000
Model No	: KGSİ-8070
Boyut / Size (mm)	: 800 x 700 x 300
Güç / Power(Kw)	: 14,00
Tüketim / Consump. (m ³ /h - Kg/h)	: 1,816 - 0,583
Hacim / Volume(m ³)	: 0,50
Ağırlık / Weight(Kg)	: 92,00
Paket Ölç./Pkg Dim(mm)	: 850 x 910 x 650
Fiyat / Price €	: 2.475,00 €



TR * Lpg ve Doğalgaz ile çalışır.

* Her brülör için kazayla sönmeye karşı gaz kesme kiti ve pilot içeren magnet emniyet ventilli gaz muslukları bulunur.

* Kızartma yüzeyi önünde yağ toplama kanalı ve tahliyesi mevcuttur.

* Kızartma sırasında süzülen yağların biriktiği yağ çekmecesi vardır.

* Kontrol panelinde pilot alevini kontrol etmek için açıklık bulunur

* Cihaz altına dolap bağlantısı yapılabilir

EN * Can be operated with Lpg and Ng gas.

* Magnet ventil gas valves with flame failure device and pilot on each burner protect against gas leakage when accidental extinguishing of the flame occurs.

* Oil canal and drain hole take place on the front side of the grill surface

* Collecting drawer for the straining oil.

* An opening takes place on the control panel to check the pilot flame situation

* Unit to be mounted on open base cupboards



Wok Ocak / Wok Cooker



Kod / Code	: 81740320100
Model No	: KGW - 4070
Boyut / Size (mm)	: 400 x 740 x 850
Güç / Power(Kw)	: 18,00
Tüketim / Consump. (m ³ /h - Kg/h)	: 1,850 - 0,540
Hacim / Volume(m ³)	: 0,28
Ağırlık / Weight(Kg)	: 56,50
Paket Ölç./Pkg Dim(mm)	: 520 x 820 x 660
Fiyat / Price €	: 1.250,00 €



Makama Hařlama / Pasta Cooker



Kod / Code	: 81740316000
Model No	: KEM - 4070
Boyut / Size (mm)	: 400 x 700 x 300
Güç / Power(Kw)	: 6,00
Sıcaklık / Temperature (°c)	: 30 - 120
Voltaj / Voltage	: 400 V
Kapasite / Capacity (Lt.)	: 15,00
Hacim / Volume(m ³)	: 0,28
Ağırlık / Weight(Kg)	: 30,00
Paket Ölç./Pkg Dim(mm)	: 520 x 820 x 660
Fiyat / Price €	: 1.375,00 €



- TR** * Isıtılan suyun sıcaklığı termostatik kumanda ile 30 -120 °C arası kontrol edilebilmektedir.
* Havuzdan suyun boşaltılması için önde 3/4" küresel vana
* Paslanmaz çelikten imal edilmiş sepetleri sayesinde pratik pişirme sağlar.
* Paslanmaz çelik konstrüksiyonu ile uzun ömürlü, kolay temizlenebilir ve hijyeniktir
* Cihaz altına dolap bağlantısı yapılabilir

- EN** * The temperature of water is controlled thermostatically between 30-120 °C
* Spherical valve to drain water from the container included on the front side
* Easy cooking through the stainless steel baskets.
Durable, easy to clean and hygienic due to its stainless steel construction.
* Unit to be mounted on open base cupboards



Döküm Ocak / Casting Stove



Kod / Code	: 81780320100
Model No	: KGSI-8070
Boyut / Size (mm)	: 800 x 700 x 300
Güç / Power(Kw)	: 18,00
Tüketim / Consump. (m ³ /h - Kg/h)	: 1,850 - 0,540
Hacim / Volume(m ³)	: 0,50
Ağırlık / Weight(Kg)	: 97,00
Paket Ölç./Pkg Dim(mm)	: 920 x 820 x 660
Fiyat / Price €	: 2.500,00 €





Patates Dinlendirme / Chips Scuttle



Kod / Code	: 81740317000
Model No	: KEP - 4070
Boyut / Size (mm)	: 400 x 700 x 300
Güç / Power (Kw)	: 0,75
Voltaj / Voltage	: 230 V
Kapasite / Capacity (Lt.)	: GN 1/1 100
Hacim / Volume (m ³)	: 0,30
Ağırlık / Weight (Kg)	: 27,50
Paket Ölç./Pkg Dim (mm)	: 520 x 820 x 750
Fiyat / Price €	: 700,00 €



- TR** * GN 1/1 x 100 mm kap kapasiteli.
* Ürün arkasında yer alan infrared seramik ısıtıcı, servis edilmeden önce servis edilecek gıdanın sıcak kalmasını sağlar
* Kullanıcıya her yönden rahatlık sağlayan ergonomik dizayna sahip.
* Süzgeç sacı vasıtasıyla patateslerin yağını süzme
* Cihaz altına dolap bağlantısı yapılabilir

- EN** * GN 1/1 x 100 mm container capacity.
* Unit to have infrared heating elements positioned on the back of the unit to keep servings warm until ready to be plated and served.
* Ergonomical design provides comfort for the user.
* Through perforated sheet metal part, easy draining potatoes
* Unit to be mounted on open base cupboards



Bain Marie / Bain Marie



Kod / Code	: 81740318000
Model No	: KESB - 4070
Boyut / Size (mm)	: 400 x 700 x 300
Güç / Power(Kw)	: 1,50
Voltaj / Voltage	: 230 V
Kapasite	: GN 1/1 100
Hacim / Volume(m ³)	: 0,28
Sıcaklık / Temperature(°c)	: 30 - 120
Ağırlık / Weight(Kg)	: 26,00
Paket Ölç./Pkg Dim(mm)	: 520 x 820 x 660
Fiyat / Price €	: 625,00 €



- TR** * GN 1/1 x 100 mm kap kapasiteli.
* Ürün arkasında yer alan infrared seramik ısıtıcı, servis edilmeden önce servis edilecek gıdanın sıcak kalmasını sağlar
* Kullanıcıya her yönden rahatlık sağlayan ergonomik dizayna sahip.
* Süzgeç sacı vasıtasıyla patateslerin yağını süzme
* Cihaz altına dolap bağlantısı yapılabilir

- EN** * GN 1/1 x 100 mm container capacity.
* Unit to have infrared heating elements positioned on the back of the unit to keep servings warm until ready to be plated and served.
* Ergonomical design provides comfort for the user.
* Through perforated sheet metal part, easy draining potatoes
* Unit to be mounted on open base cupboards



Nötr Ara Tezgah / Neutral Worktop Unit

Kod / Code : 81740309000
Model No : KAT - 4070
Boyut / Size (mm) : 400 x 700 x 850
Hacim / Volume(m³) : 0,28
Ağırlık / Weight(Kg) : 20,00
Paket Ölç./Pkg Dim(mm) : 520 x 820 x 660
Fiyat / Price € : 375,00 €

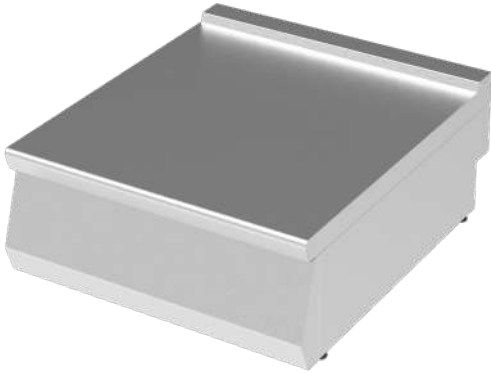

Nötr Ara Tezgah / Neutral Worktop Unit

Kod / Code : 81780309000
Model No : KAT - 8070
Boyut / Size (mm) : 800 x 700x 300
Hacim / Volume(m³) : 0,50
Ağırlık / Weight(Kg) : 33,00
Paket Ölç./Pkg Dim(mm) : 920 x 820 x 660
Fiyat / Price € : 425,00 €



Nötr Ara Tezgah / Neutral Worktop Unit

KOD Code	MODEL Model	Boyut Size	Hacim Volume m ³	Ağırlık Weight Kg.	Paket Ölç. Pkg. Dim mm	FİYAT PRICE €
81770309000	KAT-2070	200x700x300	0,50	53	520 x 820 x 660	300,00
81730309000	KAT-3070	200 x 700 x 300	0,50	35	520 x 820 x 660	325,00





Setaltı Tezgah / Under Counter Table

Kod / Code	: 81240200700
Model No	: KAD - 4070
Boyut / Size (mm)	: 400 x 610 x 550
Hacim / Volume(m ³)	: 0,29
Ağırlık / Weight(Kg)	: 15,40
Paket Ölç./Pkg Dim(mm)	: 430 x 690 x 620
Fiyat / Price €	: 325,00 €



Setaltı Tezgah / Under Counter Table

Kod / Code	: 81280200700
Model No	: KAD - 8070
Boyut / Size (mm)	: 800 x 610 x 550
Hacim / Volume(m ³)	: 0,32
Ağırlık / Weight(Kg)	: 25,00
Paket Ölç./Pkg Dim(mm)	: 830 x 690 x 620
Fiyat / Price €	: 425,00 €



Setaltı Tezgah / Under Counter Table

Kod / Code	: 81280200701
Model No	: KAD - 12070
Boyut / Size (mm)	: 1200 x 610 x 550
Hacim / Volume(m ³)	: 0,52
Ağırlık / Weight(Kg)	: 35,00
Paket Ölç./Pkg Dim(mm)	: 1320 x 690 x 620
Fiyat / Price €	: 550,0 €



Cihaz Dolap Kapısı Door for Cooking Series

Kod / Code : P1001000001
Fiyat / Price € : 40,00 €

Piřiriciler / Cookers

900 Seri / 900 Series



444 5 957
kayalarmutfak.com.tr



Ocak / Cooker



Kod / Code	: 81940821000
Model No	: KGOD-4090
Boyut / Size (mm)	: 400 x 900 x 850
Güç / Power(Kw)	: 16,50
Tüketim / Consump. (m ³ /h - Kg/h)	: 1,803 - 0,405
Hacim / Volume(m ³)	: 0,62
Ağırlık / Weight(Kg)	: 61,00
Paket Ölç./Pkg Dim(mm)	: 520 x 1000 x 1200
Fiyat / Price €	: 1.475,00 €



6,5 Kw



10 Kw



Ocak / Cooker



Kod / Code	: 81980821000
Model No	: KGOD-8090
Boyut / Size (mm)	: 800 x 900 x 850
Güç / Power(Kw)	: (6,5 x 2) + (10 x 2) = 33,00
Tüketim / Consump. (m ³ /h - Kg/h)	: 3,606 - 0,810
Hacim / Volume(m ³)	: 1,10
Ağırlık / Weight(Kg)	: 101,00
Paket Ölç./Pkg Dim(mm)	: 920 x 1000 x 1200
Fiyat / Price €	: 2.625,00 €



10 Kw



6,5 Kw

6,5 Kw

10 Kw

TR

- * Lpg ve Doğalgaz ile çalışır.
- * Brülörler primer ve seconder yanma özelliği sayesinde yüksek yanma veriminin yanında düşük atık gaz emisyonu ile dünya standartlarında ve çevrecidir.
- * Her brülör için kazayla sönmeye karşı gaz kesme kiti ve pilot içeren magnet emniyet ventilli gaz muslukları bulunur.
- * Değişik ölçülerde tencere kullanımına olanak sağlayacak şekilde tasarlanmış , ağır hizmet tipi ocak dökümleri teflon kaplıdır
- * Tek parça basılmış AISI 304 kalite paslanmaz çelik üst tabla
- * Derin çekme ocak tepleri üst tabladan bağımsız olup , temizliğe en hızlı ve kolay çözümü getirirken, hijyenik bir pişirme alanı sağlar

EN

- * Can be operated with Lpg and Ng gas.
- * The gas burners provides a high burning fertility through primary and secondary burning and is proper to the world standart
- * Magnet ventil gas valves with flame failure device and pilot on each burner protect against gas leakage when accidental extinguishing of the flame occurs.
- * Teflon coated ,hard pan support in cast iron specially designed to provide usage of different sized pans.
- * One piece pressed AISI 304 stainless steel worktop
- * Deep formed cooking departments bring fastest and ease of cleaning, assuring hygenic cooking area



Ocak / Cooker



Kod / Code	: 81940811000
Model No	: KEOD-4090
Boyut / Size (mm)	: 400 x 900 x 850
Güç / Power(Kw)	: 4 x 2 = 80,00
Voltaj / Voltage	: 400 V
Hacim / Volume(m ³)	: 0,62
Ağırlık / Weight(Kg)	: 85,00
Paket Ölç./Pkg Dim(mm)	: 520 x 1000 x 1200
Fiyat / Price €	: 1.400,00 €



4 Kw



4 Kw



Ocak / Cooker



Kod / Code	: 81980811000
Model No	: KEOD-8090
Boyut / Size (mm)	: 800 x 900 x 850
Güç / Power(Kw)	: 4 x 4 = 16,00
Voltaj / Voltage	: 400 V
Hacim / Volume(m ³)	: 1,10
Ağırlık / Weight(Kg)	: 108,00
Paket Ölç./Pkg Dim(mm)	: 920 x 1000 x 1200
Fiyat / Price €	: 2.187,50 €



4 Kw



4 Kw

4 Kw

4 Kw

- TR** * Birbirinden bağımsız olarak ısıtıcıların her biri kademeli şalter kontrolü ile çalışmaktadır.
* Tek parça basılmış üst tabla
* Kullanıcıya her yönden rahatlık sağlayan ergonomik dizayna sahiptir.
* Sağlam konstrüksiyonu ile emniyetli kullanım sağlar.
* Cihaz altına dolap bağlantısı yapılabilir

- EN** * Each of the heaters can be operated separately by gradeted switches.
* One piece pressed worktop
* Ergonomical design provides comfort to the user
* Safe usage through solid construction
* Unit to be mounted on open base cupboards



Kuzine Fırını / Range With Oven



Kod / Code	: 81980810600
Model No	: KEKF-8090
Boyut / Size (mm)	: 800 x 900 x 850
Güç / Power(Kw)	: (4 x 4) + 6 = 22,00
Voltaj / Voltage	: 400 V
Sıcaklık / Temperature (°c)	: 50-300 (Fırın / Oven)
Hacim / Volume(m ³)	: 1,10
Ağırlık / Weight(Kg)	: 153,00
Paket Ölç./Pkg Dim(mm)	: 920 x 1000 x 1200
Fiyat / Price €	: 3.125,00 €

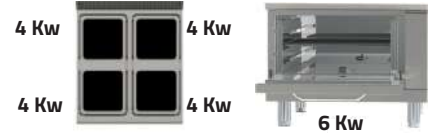

Kuzine Fırını / Range With Oven



Kod / Code	: 81920810600
Model No	: KEKFD-1290
Boyut / Size (mm)	: 1200 x 900 x 850
Güç / Power(Kw)	: (4 x 4) + 6 = 22,00
Voltaj / Voltage	: 400 V
Sıcaklık / Temperature (°c)	: 50-300 (Fırın / Oven)
Hacim / Volume(m ³)	: 1,58
Ağırlık / Weight(Kg)	: 220,00
Paket Ölç./Pkg Dim(mm)	: 1320 x 1000 x 1200
Fiyat / Price €	: 3.750,00 €



TR * Birbirinden bağımsız olarak ısıtıcıların her biri kademeli şalter kontrolü ile çalışmaktadır.

* Tek parça basılmış AISI 304 kalite paslanmaz çelik üst tabla

* Kullanıcıya her yönden rahatlık sağlayan ergonomik dizayna sahiptir.

* Sağlam konstrüksiyonu ile emniyetli kullanım sağlar.

* Fırın kapısı menteşe sistemi tek kollu olup maksimum güvenlik sağlamasının yanında iki kademeli menteşe sistemi kapı seviyelendirmesi imkanı sayesinde kullanım kolaylığı sağlar

* Yekpare fırın gövdesi paslanmaz çelikten üretilmiştir ve fırın iç sıcaklığı termostatik olarak

* 50 - 300 °C arası kontrol edilebilir.

* Fırın kısmı GN 2/1 tepsi kapasiteli ve farklı konumlarda tepsi yerleştirme özelliğine sahiptir.

EN * Each of to heaters can be operated separately by gradeted switches.

* One piece pressed AISI 304 stainless steel worktop

* Ergonomical design provides comfort to the user.

* Strong bodyconstruction brings safety usage.

* Two leveled oven hinge system with single arm brings maximum safety in usage plus leveling the door brings ease of usage.

* Monoblock oven body made of stainless steel and internal oven temperature controlled by thermostaticly between 50 - 300 °C

* Owen has GN 2/1 Capacityand accomodate different levels.



Kuzine Fırınlı Tam Boy - Range With Full Size Oven ⚡

Kod / Code	: 81920810090
Model No	: KEKBF - 12090
Boyut / Size (mm)	: 1200 x 900 x 850
Güç / Power(Kw)	: 30,00
Sıcaklık / Temperature (°c)	: 50-300
Ağırlık / Weight(Kg)	: 235,00
Paket Ölç./Pkg Dim(mm)	: 1320 x 1000 x 1200
Fiyat / Price €	: 4.740,00 €

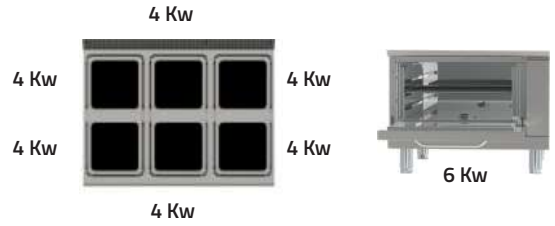

Kuzine Fırınlı Tam Boy - Range With Full Size Oven 🔥

Kod / Code	: 81920820090
Model No	: KGKBF- 12090
Boyut / Size (mm)	: 1200 x 900 x 850
Güç / Power(Kw)	: 59,50
Tüketim / Consump. (m ³ /h - Kg/h)	: 6,524 - 2,330
Ağırlık / Weight(Kg)	: 210,00
Paket Ölç./Pkg Dim(mm)	: 1320 x 100 x 1200
Fiyat / Price €	: 4.980,00 €

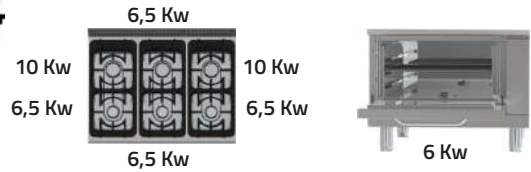

TR

- * Lpg ve Doğalgaz ile çalışır.
- * Brülörler primer ve seconder yanma özelliği sayesinde yüksek yanma veriminin yanında düşük atık gaz emisyonu ile dünya standartlarında ve çevrecidir.
- * Her brülör için kazayla sönmeye karşı gaz kesme kiti ve pilot içeren magnet emniyet ventilli gaz muslukları bulunur.
- * Değişik ölçülerde tencere kullanımına olanak sağlayacak şekilde tasarlanmış , ağır hizmet tipi ocak dökümleri teflon kaplıdır
- * Tek parça basılmış AISI 304 kalite paslanmaz çelik üst tabla
- * Fırın kapısı menteşe sistemi tek kollu olup maksimum güvenlik sağlamasının yanında iki kademeli menteşe sistemi kapı seviyelendirmesi imkanı sayesinde kullanım kolaylığı sağlar
- * Yekpare fırın gövdesi paslanmaz çelikten üretilmiştir ve fırın iç sıcaklığı termostatik olarak
- * 50 - 300 °C arası kontrol edilebilir.
- * Fırın kısmı GN 2/1 tepsi kapasiteli ve farklı konumlarda tepsi yerleştirme özelliğine sahiptir.

EN

- * Can be operated with Lpg and Ng gas.
- * The gas burners provides a high burning fertility through primary and secondary burning and is proper to the world standart
- * Magnet ventil gas valves with flame failure device and pilot on each burner protect against gas leakage when accidental extinguishing of the flame occurs.
- * Teflon coated ,hard pan support in cast iron specially designed to provide usage of different sized pans.
- * One piece pressed AISI 304 stainless steel worktop
- * Two leveled oven hinge system with single arm brings maximum safety in usage plus leveling the door brings ease of usage.
- * Monoblock oven body made of stainless steel and internal oven temperature controlled by thermostatic magnet ventil gas valve with eight levels maximum 300 °C
- * Owen has GN 2/1 Capacityand accomodate different levels.

900 Seri / Series



Kuzine li / Range With

Kod / Code	: 81980820600
Model No	: KGKF-8090
Boyut / Size (mm)	: 800 x 900 x 850
Güç / Power(Kw)	: (6,5x2) + (10x2)+6=39,00
Tüketim / Consump. (m ³ /h - Kg/h)	: 4,721 - 1,925
Sıcaklık / Temperature (° c)	: 50-300
Fırın / Oven)Hacim / Volume(m ³)	: 1,10
Ağırlık / Weight(Kg)	: 145,00
Paket Ölç./Pkg Dim(mm)	: 920 x 1000 x 1200
Fiyat / Price €	:3.625,00 €



10 Kw
6,5 Kw



6 Kw



Kuzine Fırını / Range With Oven

Kod / Code	: 81920820600
Model No	: KGKFD-1290
Boyut / Size (mm)	: 1200 x 900 x 850
Güç / Power(Kw)	: (6,5x3) + (10x3)+6=55,50
Tüketim / Consump. (m ³ /h - Kg/h)	: 6,524 - 2330
Sıcaklık / Temperature (° c)	: 50-300
(Fırın / Oven)Hacim / Volume(m ³)	: 1,58
Ağırlık / Weight(Kg)	: 195,00
Paket Ölç./Pkg Dim(mm)	: 1320 x 1000 x 1200
Fiyat / Price €	: 4.425,00 €



10 Kw
6,5 Kw



8 Kw

TR

- * Lpg ve Doğalgaz ile çalışır.
- * Brülörler primer ve seconder yanma özelliği sayesinde yüksek yanma veriminin yanında düşük atık gaz emisyonu ile dünya standartlarında ve çevrecidir.
- * Her brülör için kazayla sönmeye karşı gaz kesme kiti ve pilot içeren magnet emniyet ventilli gaz muslukları bulunur.
- * Değişik ölçülerde tencere kullanımına olanak sağlayacak şekilde tasarlanmış , ağır hizmet tipi ocak dökümleri teflon kaplıdır
- * Tek parça basılmış AISI 304 kalite paslanmaz çelik üst tabla
- * Fırın kapısı menteşe sistemi tek kollu olup maksimum güvenlik sağlamasının yanında iki kademeli menteşe sistemi kapı seviyelendirmesi imkanı sayesinde kullanım kolaylığı sağlar
- * Yekpare fırın gövdesi paslanmaz çelikten üretilmiştir ve fırın iç sıcaklığı termostatik olarak
- * 50 - 300 °C arası kontrol edilebilir.
- * Fırın kısmı GN 2/1 tepsi kapasiteli ve farklı konumlarda tepsi yerleştirme özelliğine sahiptir.

EN

- * Can be operated with Lpg and Ng gas.
- * The gas burners provides a high burning fertility through primary and secondary burning and is proper to the world standart
- * Magnet ventil gas valves with flame failure device and pilot on each burner protect against gas leakage when accidental extinguishing of the flame occurs.
- * Teflon coated ,hard pan support in cast iron specially designed to provide usage of different sized pans.
- * One piece pressed AISI 304 stainless steel worktop
- * Two leveled oven hinge system with single arm brings maximum safety in usage plus leveling the door brings ease of usage.
- * Monoblock oven body made of stainless steel and internal oven temperature controlled by thermostatic magnet ventil gas valve with eight levels maximum 300 °C
- * Owen has GN 2/1 Capacityand accomodate different levels.



Ocak / Cooker



Kod / Code	: 81920811000
Model No	: KEOD-1290
Boyut / Size (mm)	: 1200 x 900 x 850
Güç / Power(Kw)	: 4 x 6 = 24,00
Voltaj / Voltage	: 400 V
Hacim / Volume(m ³)	: 1,58
Ağırlık / Weight(Kg)	: 185,00
Paket Ölç./Pkg Dim(mm)	: 1320 x 1000 x 1200
Fiyat / Price €	: 3.162,50 €

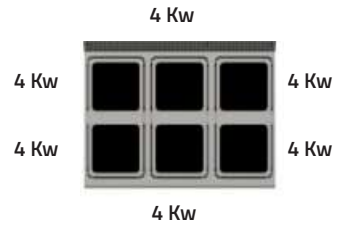

Ocak / Cooker



Kod / Code	: 81920821000
Model No	: KGOD-1290
Boyut / Size (mm)	: 1200 x 900 x 850
Güç / Power(Kw)	: (6,5x3)+(10x3)=49,50
Tüketim / Consump. (m ³ /h - Kg/h)	: 5,409 - 1215
Hacim / Volume(m ³)	: 1,58
Ağırlık / Weight(Kg)	: 165,00
Paket Ölç./Pkg Dim(mm)	: 1320 x 1000 x 1200
Fiyat / Price €	: 3.662,50 €

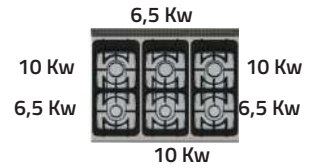

- TR** * Isıtıcılar, temizleme ve bakım kolaylığı için kaldırılabılır şekilde ve ısıyı homojen yayacak biçimde tasarlanmıştır
- * Yağ sıcaklığının maksimum 180 °C' e kadar termostatik kontrolü
- * Yağın aşırı ısınması durumunda limit termostat ısıtıcıları devre dışı bırakır ve emniyetli çalışma sağlar.
- * Uzun ömürlü, kolay temizlenebilir ve hijyeniktir.
- * Havuzdan yağın boşaltılması için önde 3/4" küresel vana
- * Maksimum güvenliği sağlamak için ; temizlik ve bakım esnasında ısıtıcı sistemi yukarıdayken , ısıtıcı enerjisini kesen sistem cihaza dahil edilmiştir.
- * Cihaz altına dolap bağlantısı yapılabilir

- EN** * Liftable heating system with resistances designed for homogeneous heat distribution, provides easy cleaning and maintenance.
- * Thermostatic regulation of oil temperature up to a maximum of 180 °C.
- * In case of over heating of the oil , limit thermostat stops the heating elements and provides safety operate.
- * Long life, easy cleaning, and hygienic due to its stainless steel construction.
- * Spherical valve to drain oil from the container included on the front side
- * Safety system shutting off energy of the heaters included, to provide maximum safety through maintenance and cleaning while heat system lifted up



Fritöz/Deep Fryer



Kod / Code	: 81940812000
Model No	: KEFD - 4090
Boyut / Size (mm)	: 400 x 900 x 850
Güç / Power(Kw)	: 15,00
Sıcaklık / Temperature (°c)	: 100 - 190
Voltaj / Voltage	: 400 V
Kapasite / Capacity (Lt)	: 30,00
Hacim / Volume(m ³)	: 0,62
Ağırlık / Weight(Kg)	: 62,00
Paket Ölç./Pkg Dim(mm)	: 520 x 1000 x 1200
Fiyat / Price €	: 1.850,00 €



Fritöz/Deep Fryer



Kod / Code	: 81980812000
Model No	: KEFD - 8090
Boyut / Size (mm)	: 800 x 900 x 850
Güç / Power(Kw)	: 15+15 = 30,00
Sıcaklık / Temperature (°c)	: 100 - 190
Voltaj / Voltage	: 400 V
Kapasite / Capacity (Lt)	: 30,00 + 30,00
Hacim / Volume(m ³)	: 1,10
Ağırlık / Weight(Kg)	: 100,00
Paket Ölç./Pkg Dim(mm)	: 920 x 1000 x 1200
Fiyat / Price €	: 3.500,00 €



- TR** * Isıtıcılar, temizleme ve bakım kolaylığı için kaldırılabilir şekilde ve ısıyı homojen yayacak biçimde tasarlanmıştır
- * Yağ sıcaklığının maksimum 190 °C' e kadar termostatik kontrolü
- * Yağın aşırı ısınması durumunda limit termostat ısıtıcıları devre dışı bırakır ve emniyetli çalışma sağlar.
- * Uzun ömürlü, kolay temizlenebilir ve hijyeniktir.
- * Havuzdan yağın boşaltılması için 3/4" küresel vana
- * Maksimum güvenliği sağlamak için ; temizlik ve bakım esnasında ısıtıcı sistemi yukarıdayken , ısıtıcı enerjisini kesen sistem cihaza dahil edilmiştir.
- * Cihaz altına dolap bağlantısı yapılabilir

- EN** * Lifiable heating system with resistances designed for homogeneous heat distribution, provides easy cleaning and maintenance.
- * Thermostatic regulation of oil temperature up to a maximum of 190 °C.
- * In case of over heating of the oil , limit thermostat stops the heating elements and provides safety operate.
- * Long life, easy cleaning, and hygienic due to its stainless steel construction.
- * Spherical valve to drain oil from the container included
- * Safety system shutting off energy of the heaters included, to provide maximum safety through maintenance and cleaning while heat system lifted up



Fritöz/Deep Fryer



Kod / Code	: 81940822000
Model No	: KGFD - 4090
Boyut / Size (mm)	: 400 x 900 x 850
Güç / Power(Kw)	: 18,00
Sıcaklık / Temperature (°c)	: 100 - 190
Tüketim / Consump. (m ³ /h - Kg/h)	: 1,805 - 0,540
Kapasite / Capacity (Lt)	: 30,00
Hacim / Volume(m ³)	: 0,70
Ağırlık / Weight(Kg)	: 70,00
Paket Ölç./Pkg Dim(mm)	: 520 x 1000 x 1350
Fiyat / Price €	: 2.500,00 €



Fritöz/Deep Fryer



Kod / Code	: 81980822000
Model No	: KGFD - 8090
Boyut / Size (mm)	: 800 x 900 x 850
Güç / Power(Kw)	: 18+18 = 36,00
Sıcaklık / Temperature (°c)	: 100 - 190
Tüketim / Consump. (m ³ /h - Kg/h)	: 3,700 - 1,080
Kapasite / Capacity (Lt)	: 30,00 + 30,00
Hacim / Volume(m ³)	: 1,24
Ağırlık / Weight(Kg)	: 118,00
Paket Ölç./Pkg Dim(mm)	: 920 x 1000 x 1350
Fiyat / Price €	: 4.750,00 €



TR * Lpg ve Doğalgaz ile çalışır.ısıtıcılar, temizleme ve bakım kolaylığı için kaldırılabilir şekilde ve ısıyı homojen yayacak biçimde tasarlanmıştır
* Yağ sıcaklığının maksimum 190 °C' e kadar termostatik kontrolü
* Yağın aşırı ısınması durumunda limit termostat ısıtıcıları devre dışı bırakır ve emniyetli çalışma sağlar.
* Uzun ömürlü, kolay temizlenebilir ve hijyeniktir.
* Havuzdan yağın boşaltılması için 3/4" küresel vana Maksimum güvenliği sağlamak için ; temizlik ve bakım esnasında ısıtıcı sistemi yukarıdayken , ısıtıcı enerjisini kesen sistem cihaza dahil edilmiştir.

EN * Can be operated with LPG and NG Gas
* Lifiable heating system with resistances designed for homogeneous heat distribution, provides easy cleaning and maintenance
* Thermostatic regulation of oil temperature up to a maximum of 190 °C
* In case of over heating of the oil, limit thermostat stops the heating elements and provides safety operate.
* Long life, easy cleaning and hygienic due to its
* Spherical valve to drain oil from the container
* Safety system shutting off energy of the heaters



Chrome Surface 450 €

Izgara Düz / Grill Smooth



Kod / Code	: 81940823010
Model No	: KGDID - 4090
Boyut / Size (mm)	: 400 x 900 x 850
Güç / Power(Kw)	: 10,00
Tüketim / Consump. (m ³ /h - Kg/h)	: 0,980 - 0,321
Hacim / Volume(m ³)	: 0,62
Ağırlık / Weight(Kg)	: 100,00
Paket Ölç./Pkg Dim(mm)	: 520 x 1000 x 1200
Fiyat / Price €	: 1.500,00 €



Chrome Surface 700 €

Izgara Düz / Grill Smooth



Kod / Code	: 81980823010
Model No	: KGDID - 8090
Boyut / Size (mm)	: 800 x 900 x 850
Güç / Power(Kw)	: 20,00
Tüketim / Consump. (m ³ /h - Kg/h)	: 1,960 - 1,418
Hacim / Volume(m ³)	: 1,10
Ağırlık / Weight(Kg)	: 155,00
Paket Ölç./Pkg Dim(mm)	: 920 x 1000 x 1200
Fiyat / Price €	: 2.500,00 €



- TR** * Lpg ve Doğalgaz ile çalışır.
* Her brülör için kazayla sönmeye karşı gaz kesme kiti ve pilot içeren magnet emniyet ventilli gaz muslukları bulunur.
* Kızartma yüzeyi önünde yağ toplama kanalı ve tahliyesi mevcuttur.
* Kızartma sırasında süzölen yağların biriktiği yağ çekmecesini vardır.
* Kontrol panelinde pilot alevini kontrol etmek için açıklık bulunur
* Cihaz altına dolap bağlantısı yapılabilir

- EN** * Can be operated with Lpg and Ng gas.
* Magnet ventil gas valves with flame failure device and pilot on each burner protect against gas leakage when accidental extinguishing of the flame occurs.
* Oil canal and drain hole take place on the front side of the grill surface
* Collecting drawer for the straining oil.
* An opening takes place on the control panel to check the pilot flame situation
* Unit to be mounted on open base cupboards



Chorome Surface 450 €

Izgara Oluklu / Grill Ribbed



Kod / Code	: 81940823020
Model No	: KGOID - 4090
Boyut / Size (mm)	: 400 x 900 x 850
Güç / Power(Kw)	: 10,00
Tüketim / Consump. (m ³ /h - Kg/h)	: 0,980 - 0,321
Hacim / Volume(m ³)	: 0,62
Ağırlık / Weight(Kg)	: 100,00
Paket Ölç./Pkg Dim(mm)	: 520 x 1000 x 1200
Fiyat / Price €	: 1.700,00 €



Chorome Surface 700 €

Izgara Oluklu / Grill Ribbed



Kod / Code	: 81980823020
Model No	: KGOID - 8090
Boyut / Size (mm)	: 800 x 900 x 850
Güç / Power(Kw)	: 20,00
Tüketim / Consump. (m ³ /h - Kg/h)	: 1,960 - 1,418
Hacim / Volume(m ³)	: 1,10
Ağırlık / Weight(Kg)	: 155,00
Paket Ölç./Pkg Dim(mm)	: 920 x 1000 x 1200
Fiyat / Price €	: 2.750,00 €



- TR** * Lpg ve Doğalgaz ile çalışır.
* Her brülör için kazayla sönmeye karşı gaz kesme kiti ve pilot içeren magnet emniyet ventilli gaz muslukları bulunur.
* Kızartma yüzeyi önünde yağ toplama kanalı ve tahliyesi mevcuttur.
* Kızartma sırasında süzülen yağların biriktiği yağ çekmecesi vardır.
* Kontrol panelinde pilot alevini kontrol etmek için açıklık bulunur
* Cihaz altına dolap bağlantısı yapılabilir

- EN** * Can be operated with Lpg and Ng gas.
* Magnet ventil gas valves with flame failure device and pilot on each burner protect against gas leakage when accidental extinguishing of the flame occurs.
* Oil canal and drain hole take place on the front side of the grill surface
* Collecting drawer for the straining oil.
* An opening takes place on the control panel to check the pilot flame situation
* Unit to be mounted on open base cupboards



Chrome Surface 700 €

Izgara 1/2 Oluklu / 1/2 Grill Ribbed



Kod / Code	: 81980823030
Model No	: KGYID - 8090
Boyut / Size (mm)	: 800 x 900 x 850
Güç / Power(Kw)	: 18,00
Tüketim / Consump. (m ³ /h - Kg/h)	: 1,960 - 1,418
Hacim / Volume(m ³)	: 1,10
Ağırlık / Weight(Kg)	: 155,00
Paket Ölç./Pkg Dim(mm)	: 920 x 1000 x 1200
Fiyat / Price €	: 2.750,00 €



- TR** * Lpg ve Doğalgaz ile çalışır.
* Her brülör için kazayla sönmeye karşı gaz kesme kiti ve pilot içeren magnet emniyet ventilli gaz muslukları bulunur.
* Kızartma yüzeyi önünde yağ toplama kanalı ve tahliyesi mevcuttur.
* Kızartma sırasında süzülen yağların biriktiği yağ çekmecesi vardır.
* Kontrol panelinde pilot alevini kontrol etmek için açıklık bulunur
* Cihaz altına dolap bağlantısı yapılabilir

- EN** * Can be operated with Lpg and Ng gas.
* Magnet ventil gas valves with flame failure device and pilot on each burner protect against gas leakage when accidental extinguishing of the flame occurs.
* Oil canal and drain hole take place on the front side of the grill surface
* Collecting drawer for the straining oil.
* An opening takes place on the control panel to check the pilot flame situation
* Unit to be mounted on open base cupboards



Izgara 1/2 Oluklu / 1/2 Grill Ribbed



Kod / Code	: 81980813030
Model No	: KEYID - 8090
Boyut / Size (mm)	: 800 x 900 x 850
Güç / Power(Kw)	: 9,60
Sıcaklık / Temperature (°c)	: 50 - 300
Hacim / Volume(m ³)	: 1,10
Voltaj / Voltage	: 400 V
Ağırlık / Weight(Kg)	: 155,00
Paket Ölç./Pkg Dim(mm)	: 920 x 1000 x 1200
Fiyat / Price €	: 2.750,00 €





Izgara Düz / Grill Smooth



Kod / Code	: 81940813010
Model No	: KEDID - 4090
Boyut / Size (mm)	: 400 x 900 x 850
Güç / Power(Kw)	: 3,20
Sıcaklık / Temperature (°c)	: 50 - 300
Voltaj / Voltage	: 400 V
Hacim / Volume(m ³)	: 0,62
Ağırlık / Weight(Kg)	: 82,00
Paket Ölç./Pkg Dim(mm)	: 520 x 1000 x 1200
Fiyat / Price €	: 1.375,00 €



Izgara Düz / Grill Smooth



Kod / Code	: 81980813010
Model No	: KEDID - 8090
Boyut / Size (mm)	: 800 x 900 x 850
Güç / Power(Kw)	: 9,60
Sıcaklık / Temperature (°c)	: 50 - 300
Voltaj / Voltage	: 400 V
Hacim / Volume(m ³)	: 1,10
Ağırlık / Weight(Kg)	: 155,00
Paket Ölç./Pkg Dim(mm)	: 920 x 1000 x 1200
Fiyat / Price €	: 2.500,00 €



- TR** * Kızartma yüzeyi önünde yağ toplama kanalı ve tahliyesi
* Kızartma sırasında süzölen yağların biriktiđi yağ çekmecesi mevcuttur.
* 50-300 °C arası termostatik sıcaklık kontrolü.
* Uzun ömürlü, kolay temizlenebilir ve hijyeniktir.
* Cihaz altına dolap bağlantısı yapılabilir

- EN** * Oil canal and drain hole take place on the front side of the grill surface
* Collecting drawer for the straining oil.
* Thermostatic regulation of temperature between 50-300 °C.
* Long life, easy cleaning, and hygienic due to its stainless steel construction.
* Unit to be mounted on open base cupboards



Izgara Oluklu / Grill Ribbed



Kod / Code	: 81940813020
Model No	: KEOID - 4090
Boyut / Size (mm)	: 400 x 900 x 850
Güç / Power(Kw)	: 3,20
Sıcaklık / Temperature (°c)	: 50 - 300
Voltaj / Voltage	: 400 V
Hacim / Volume(m ³)	: 0,62
Ağırlık / Weight(Kg)	: 82,00
Paket Ölç./Pkg Dim(mm)	: 520 x 1000 x 1200
Fiyat / Price €	: 1.625,00 €



Izgara Oluklu / Grill Ribbed

Kod / Code	: 81980813020
Model No	: KEOID - 8090
Boyut / Size (mm)	: 800 x 900 x 850
Güç / Power(Kw)	: 9,60
Sıcaklık / Temperature (°c)	: 50 - 300
Voltaj / Voltage	: 400 V
Hacim / Volume(m ³)	: 1,10
Ağırlık / Weight(Kg)	: 155,00
Paket Ölç./Pkg Dim(mm)	: 920 x 1000 x 1200
Fiyat / Price €	: 2.750,00 €



- TR** * Kızartma yüzeyi önünde yağ toplama kanalı ve tahliyesi
* Kızartma sırasında süzölen yağların biriktiği yağ çekmecesini mevcuttur.
* 50-300 °C arası termostatik sıcaklık kontrolü.
* Uzun ömürlü, kolay temizlenebilir ve hijyeniktir.
* Cihaz altına dolap bağlantısı yapılabilir

- EN** * Oil canal and drain hole take place on the front side of the grill surface
* Collecting drawer for the straining oil.
* Thermostatic regulation of temperature between 50-300 °C.
* Long life, easy cleaning, and hygienic due to its stainless steel construction.
* Unit to be mounted on open base cupboards



Izgara Lavatař / Lavastone Grill



Kod / Code	: 81920824000
Model No	: KGLI - 120090
Boyut / Size (mm)	: 1200 x 900 x 850
Güç / Power(Kw)	: 30,00
Tüketim / Consump. (m ³ /h - Kg/h)	: 3,203 - 1,125
Hacim / Volume(m ³)	: 1,58
Ağırlık / Weight(Kg)	: 150,00
Paket Ölç./Pkg Dim(mm)	: 1320 x 1000 x 1200
Fiyat / Price €	: 3.750,00 €



Izgara Sulu Döküm / Lavastone Water Grill



Kod / Code	: 81920825000
Model No	: KGSID - 120090
Boyut / Size (mm)	: 1200 x 900 x 850
Güç / Power(Kw)	: 30,00
Tüketim / Consump. (m ³ /h - Kg/h)	: 3,203 - 1,125
Hacim / Volume(m ³)	: 1,58
Ağırlık / Weight(Kg)	: 150,00
Paket Ölç./Pkg Dim(mm)	: 1320 x 1000 x 1200
Fiyat / Price €	: 3.750,00 €



TR

- * Lpg ve Doğalgaz ile çalışır.
- * Her brülör için kazayla sönmeye karşı gaz kesme kiti ve pilot içeren magnet emniyet ventilli gaz muslukları bulunur.
- * Kızartma yüzeyi önünde yağ toplama kanalı ve tahliyesi mevcuttur.
- * Kızartma sırasında süzülen yağların biriktiği yağ çekmecesi vardır.
- * Kontrol panelinde pilot alevini kontrol etmek için açıklık bulunur
- * Cihaz altına dolap bağlantısı yapılabilir

EN

- * Can be operated with Lpg and Ng gas.
- * Magnet ventil gas valves with flame failure device and pilot on each burner protect against gas leakage when accidental extinguishing of the flame occurs.
- * Oil canal and drain hole take place on the front side of the grill surface
- * Collecting drawer for the straining oil.
- * An opening takes place on the control panel to check the pilot flame situation
- * Unit to be mounted on open base cupboards



Izgara Lavatař / Lavastone Grill



Kod / Code	: 81940824000
Model No	: KGLID - 4090
Boyut / Size (mm)	: 400 x 900 x 850
Güç / Power(Kw)	: 10,00
Tüketim / Consump. (m ³ /h - Kg/h)	: 1,067 - 0,371
Hacim / Volume(m ³)	: 0,62
Ağırlık / Weight(Kg)	: 88,00
Paket Ölç./Pkg Dim(mm)	: 520 x 1000 x 1200
Fiyat / Price €	: 1.750,00 €



Izgara Lavatař / Lavastone Grill



Kod / Code	: 81980824000
Model No	: KGLID - 8090
Boyut / Size (mm)	: 800 x 900 x 850
Güç / Power(Kw)	: 20,00
Tüketim / Consump. (m ³ /h - Kg/h)	: 2,134 - 0,750
Hacim / Volume(m ³)	: 1,10
Ağırlık / Weight(Kg)	: 144,00
Paket Ölç./Pkg Dim(mm)	: 920 x 1000 x 1200
Fiyat / Price €	: 2.675,00 €



TR

- * Lpg ve Doğalgaz ile çalışır.
- * Her brülör için kazayla sönmeye karşı gaz kesme kiti ve pilot içeren magnet emniyet ventilli gaz muslukları bulunur.
- * Kızartma yüzeyi önünde yağ toplama kanalı ve tahliyesi mevcuttur.
- * Kızartma sırasında süzülen yağların biriktiği yağ çekmecesi vardır.
- * Kontrol panelinde pilot alevini kontrol etmek için açıklık bulunur
- * Cihaz altına dolap bağlantısı yapılabilir

EN

- * Can be operated with Lpg and Ng gas.
- * Magnet ventil gas valves with flame failure device and pilot on each burner protect against gas leakage when accidental extinguishing of the flame occurs.
- * Oil canal and drain hole take place on the front side of the grill surface
- * Collecting drawer for the straining oil.
- * An opening takes place on the control panel to check the pilot flame situation
- * Unit to be mounted on open base cupboards



Izgara Sulu Döküm / Lavastone Water



Kod / Code	: 81940825000
Model No	: KGSID - 4090
Boyut / Size (mm)	: 400 x 900 x 850
Güç / Power(Kw)	: 10,00
Tüketim / Consump. (m ³ /h - Kg/h)	: 1,067 - 0,375
Hacim / Volume(m ³)	: 0,62
Ağırlık / Weight(Kg)	: 88,00
Paket Ölç./Pkg Dim(mm)	: 520 x 1000 x 1200
Fiyat / Price €	: 1.950,00 €



Izgara Sulu Döküm / Lavastone Water



Kod / Code	: 81980825000
Model No	: KGSID - 8090
Boyut / Size (mm)	: 800 x 900 x 850
Güç / Power(Kw)	: 20,00
Tüketim / Consump. (m ³ /h - Kg/h)	: 2,134 - 0,750
Hacim / Volume(m ³)	: 1,10
Ağırlık / Weight(Kg)	: 144,00
Paket Ölç./Pkg Dim(mm)	: 920 x 1000 x 1200
Fiyat / Price €	: 2.875,00 €



- TR** * Lpg ve Doğalgaz ile çalışır.
* Her brülör için kazayla sönmeye karşı gaz kesme kiti ve pilot içeren magnet emniyet ventilli gaz muslukları bulunur.
* Kızartma yüzeyi önünde yağ toplama kanalı ve tahliyesi mevcuttur.
* Kızartma sırasında süzülen yağların biriktiği yağ çekmecesi vardır.
* Kontrol panelinde pilot alevini kontrol etmek için açıklık bulunur
* Cihaz altına dolap bağlantısı yapılabilir

- EN** * Can be operated with Lpg and Ng gas.
* Magnet ventil gas valves with flame failure device and pilot on each burner protect against gas leakage when accidental extinguishing of the flame occurs.
* Oil canal and drain hole take place on the front side of the grill surface
* Collecting drawer for the straining oil.
* An opening takes place on the control panel to check the pilot flame situation
* Unit to be mounted on open base cupboards



Makarna Hařlama / Pasta Cooker



Kod / Code	: 81940816000
Model No	: KEMD - 4090
Boyut / Size (mm)	: 400 x 900 x 850
Güç / Power(Kw)	: 9,00
Sıcaklık / Temperature (° c)	: 30 - 120
Kapasite / Capacity	: 30
Voltaj / Voltage	: 400 V
Hacim / Volume(m ³)	: 0,62
Ağırlık / Weight(Kg)	: 82,00
Paket Ölç./Pkg Dim(mm)	: 520 x 1000 x 1200
Fiyat / Price €	: 2.000,00 €



- TR** * Isıtılan suyun sıcaklığı termostatik kumanda ile 30 -120 °C arası kontrol edilebilmektedir.
* Havuzdan suyun boşaltılması için önde 3/4" küresel vana
* Paslanmaz çelikten imal edilmiş sepetleri sayesinde pratik pişirme sağlar.
* Paslanmaz çelik konstrüksiyonu ile uzun ömürlü, kolay temizlenebilir ve hijyeniktir
* Cihaz altına dolap bağlantısı yapılabilir

- EN** * The temperature of water is controlled thermostatically between 30-120 °C
* Spherical valve to drain water from the container included on the front side
* Easy cooking through the stainless steel baskets.
Durable, easy to clean and hygienic due to its stainless steel construction.
* Unit to be mounted on open base cupboards



Patates Dinlendirme / Chips Scuttle



Kod / Code	: 81940817000
Model No	: KEPD - 4090
Boyut / Size (mm)	: 400 x 900 x 850
Güç / Power(Kw)	: 0,75
Kapasite / Capacity (Lt.)	: GN 1/1 100
Voltaj / Voltage	: 230 V
Hacim / Volume(m ³)	: 0,62
Ağırlık / Weight(Kg)	: 50,00
Paket Ölç./Pkg Dim(mm)	: 520 x 1000 x 1200
Fiyat / Price €	: 1.200,00 €



- TR** * GN 1/1 x 100 mm kap kapasiteli.
* Ürün arkasında yer alan infrared seramik ısıtıcı, servis edilmeden önce servis edilecek gıdanın sıcak kalmasını sağlar
* Kullanıcıya her yönden rahatlık sağlayan ergonomik dizayna sahip.
* Süzgeç sacı vasıtasıyla patateslerin yağını süzme
* Cihaz altına dolap bağlantısı yapılabilir

- EN** * GN 1/1 x 100 mm container capacity.
* Unit to have infrared heating elements positioned on the back of the unit to keep servings warm until ready to be plated and served.
* Ergonomical design provides comfort for the user.
* Through perforated sheet metal part, easy draining potatoes
* Unit to be mounted on open base cupboards



Bain Marie / Bain Marie



Kod / Code	: 81940818000
Model No	: KESBD - 4090
Boyut / Size (mm)	: 400 x 900 x 850
Güç (Kw)	: 1,50
Voltaj / Voltage	: 230 V
Kapasite	: GN 1/1 100
Hacim / Volume(m ³)	: 0,62
Sıcaklık / Temperature(°c)	: 30 - 120
Ağırlık / Weight(Kg)	: 52,00
Paket Ölç./Pkg Dim(mm)	: 520 x 1000 x 1200
Fiyat / Price €	: 1.200,00 €



Patates Dinlendirme / Chips Scuttle



Kod / Code	: 81980820100
Model No	: KGDOD-8090
Boyut / Size (mm)	: 800 x 900 x 850
Güç / Power(Kw)	: 18,00
Hacim / Volume(m ³)	: 1,10
Ağırlık / Weight(Kg)	: 112,00
Paket Ölç./Pkg Dim(mm)	: 920 x 1000 x 1200
Fiyat / Price €	: 2.690,00 €





Nötr Ara Tezgah / Neutral Worktop Unit

Kod / Code	: 81940809000
Model No	: KATD - 4090
Boyut / Size (mm)	: 400 x 900 x 850
Hacim / Volume(m ³)	: 0,62
Ağırlık / Weight(Kg)	: 44,00
Paket Ölç./Pkg Dim(mm)	: 520 x 1000 x 1200
Fiyat / Price €	: 573,00 €



Nötr Ara Tezgah / Neutral Worktop Unit

Kod / Code	: 81980809000
Model No	: KATD - 8090
Boyut / Size (mm)	: 800 x 930 x 850
Hacim / Volume(m ³)	: 1,10
Ağırlık / Weight(Kg)	: 67,00
Paket Ölç./Pkg Dim(mm)	: 920 x 1000 x 1200
Fiyat / Price €	: 825,00 €





Devrilir Tava / Tilting Pan



KOD Code	Model	KAPASİTE Capacity (Lt)	GÜÇ Power (kw)	EBAT Size (mm)	PAKET Ölçüsü DIMENSION SIZE (mm)	AĞIRLIK WEIGHT (KG)	Fiyat Price €
81980810500	KEDT-8090	80,00	12,00	800 x 900 x 850	920 x 1000 x 1200	148,00	4.500,00
81980810500	KEDT-8090	120,00	12,00	900 x 900 x 850	950 x 1120 x 1200	152,00	5.875,00



Devrilir Tava / Tilting Pan



KOD Code	Model	KAPASİTE Capacity (Lt)	GÜÇ Power (kw)	EBAT Size (mm)	PAKET Ölçüsü DIMENSION SIZE (mm)	AĞIRLIK WEIGHT (KG)	Fiyat Price €
81980820500	KGDT-8090	80,00	18,00	800 x 900 x 850	920 x 1000 x 1200	155,00	4.500,00
81910820500	KGDT-9090	120,00	18,00	900 x 900 x 850	950 x 1120 x 1200	158,00	5.875,00

- TR** * Cihaz gövdesi 18/8 Cr-Ni paslanmaz çelik taşlı saçtan üretilmiştir.
* Kapak, mukavemet açısından özel form verilmiş paslanmaz çelik saçtan çift cidarlı olarak üretilmiştir.
* Tava tabanı 12mm paslanmaz çelik saçtan üretilmiştir, böylece ısının homojen yayılması ve uzun süre muhafazası sağlanmıştır.
* Devirme tertibatı özel mekanizması ile kuvvet gerektirmeden kolaylıkla çevrilebilir yapıda ve devirme açısı 85 derecedir.
* Tavaya temizleme ya da kullanım amacıyla su doldurmak için sıcak ve soğuk su verebilen musluk montelidir.
* Çok kademeli termostat ile 50-300C arasında sıcaklık ayar imkanına sahiptir.
* Tavada herhangi bir arıza olma durumunda otomatik olarak enerjiyi kesen emniyet sistemi (limit termostat) vardır.
* Tüm elektrik / gaz kumanda ve kontrol donanımları uluslararası standartlara uygundur.

- EN** * Device body is made from 18/8 Cr-Ni stainless steel stone plate.
* Cover is made from stainless steel plate which is special formed for endurance and double wall.
* Pan bottom is made from 12mm stainless steel plate, thus temperature can spread homogeneous and preserve longer.
* Overturn equipment with its special mechanism can be turned without force and overturn angle is 85.
* Pan has a tap for cleaning or usage for hot and cold water.
* Multi stage thermostat can adjust temperature between 50-300°C
* There is a safety system that cut the electricity if any malfunction occurs at pan (limited thermostat).
* All electrical / gas and control equipment are suitable to international standards.

900 Seri / Series



Kaynatma Kazanı / Boiling Pan



KOD Code	Model	KAPASİTE Capacity (Lt)	GÜÇ Power (kw)	EBAT Size (mm)	PAKET Ölçüsü DIMENSION SIZE (mm)	AĞIRLIK WEIGHT (KG)	Fiyat Price €
81980810400	INDIRECT	150,00	12,00	800 x 900 x 850	920 x 1000 x 1200	150,00	7.137,50 €
81910810400	INDIRECT	250,00	12,00	900 x 900 x 850	950 x 1270 x 1250	152,00	9.750,00 €



Kaynatma Kazanı / Boiling Pan



KOD Code	Model	KAPASİTE Capacity (Lt)	GÜÇ Power (kw)	EBAT Size (mm)	PAKET Ölçüsü DIMENSION SIZE (mm)	AĞIRLIK WEIGHT (KG)	Fiyat Price €
81980820400	INDIRECT	150,00	23,00	800 x 900 x 850	920 x 1000 x 1200	177,00	7.912,50 €
81910820400	INDIRECT	250,00	26,00	900 x 1050 x 900	950 x 1270 x 1250	225,00	10.500,00 €

- TR** * Cihaz gövdesi 18/8 Cr-Ni paslanmaz çelik tařlı saçtan üretilmiřtir.
 * Kapak, mukavemet açısından özel form verilmiř paslanmaz çelik saçtan üretilmiřtir.
 * Benmari sistemi ile kazan çevresinde dolařan yađ ile indirekt olarak piřirme yapar.
 * Çok kademeli termostat ile 60-180C arasında sıcaklık ayar imkanına sahiptir.
 * Kazan çevresindeki (ceket) yađın kaynama sıcaklıđı 200° C'nin üzerindedir.
 * Su doldurma (sođuk/sıcak) ve boşaltma vanaları cihaz üzerine montelidir.
 * Piřirilen malzemenin boşaltılması için özel řekillendirilmiř istem dıřı açılmalara karřı emniyetli boşaltma vanası vardır
 * Herhangi bir arıza olma durumunda otomatik olarak enerjiyi kesen emniyet sistemi (limit termostat)
 * Tüm elektrik / gaz kumanda ve kontrol donanımları uluslararası standartlara uygundur.
 * Isıtma Tipi: Indirekt

- EN** * Device body is made from 18/8 Cr-Ni stainless steel stone plate.
 * Cover is made from stainless steel plate which is special formed for endurance.
 * Indirect cooking is available with bain-marie system in which oil goes around pan.
 * Multi stage thermostat can adjust temperature between 60-180° C
 * Oil's, around pan (jacket), boiling temperature is over 200° C
 * Water filling (hot/cold) and draining valves are on the device.
 * There is a safety discharge valve for cooked material which is specially formed for undesirable openings
 * There is a safety system that cut the electricity if any malfunction occurs at pan (limited thermostat)
 * All electrical / gas and control equipment are suitable to international standards.
 * Heating type: Indirect



Fritöz/Deep Fryer



Kod / Code	: 803490151
Boyut / Size (mm)	: 400 x 768 x 933
Güç / Power(Kw)	: 22,00
Kapasite / Capacity (Lt)	: 35,00
Sıcaklık / Temperature (°c)	: 100 - 190
Hacim / Volume(m³)	: 0,70
Ağırlık / Weight(Kg)	: 72,00
Paket Ölç./Pkg Dim(mm)	: 500 x 1050 x 1200
Fiyat / Price €	: 2.100,00 €



Fritöz/Deep Fryer



Kod / Code	: 803890151
Boyut / Size (mm)	: 800 x 768 x 933
Güç / Power(Kw)	: 22 + 22 = 44,00
Sıcaklık / Temperature (°c)	: 100 - 190
Kapasite / Capacity (Lt)	: 35,00 + 35,00
Hacim / Volume(m³)	: 1,20
Ağırlık / Weight(Kg)	: 115,00
Paket Ölç./Pkg Dim(mm)	: 900 x 1050 x 1200
Fiyat / Price €	: 3.500,00 €



TEKLi VE ÇİFTLi FRİTÖZ SINGLE AND DOUBLE FRYER

KOD Code	EBAT Size (mm)	GERİLİM Energy	KAPASİTE Capacity (Lt.)	GÜÇ Power (kW)	FİYAT PRICE €
802130112	175 x 415 x 300	230V	5,00	3,00	175,00
802230132	270 x 415 x 300	230V	8,00	3,00	200,00
802430142	370 x 415 x 300	230V	5,00+5,00	3,00 x 2,00	287,50



Setaltı Tezgah / Under Counter Table

Kod / Code	: 81540200700
Model No	: KAD - 4070
Boyut / Size (mm)	: 400 x 810 x 550
Hacim / Volume(m ³)	: 0,17
Ağırlık / Weight(Kg)	: 20,00
Paket Ölç./Pkg Dim(mm)	: 500 x 1030 x 650
Fiyat / Price €	: 450,00 €



Setaltı Tezgah / Under Counter Table

Kod / Code	: 81580200700
Model No	: KAD - 8090
Boyut / Size (mm)	: 800 x 810 x 550
Hacim / Volume(m ³)	: 0,50
Ağırlık / Weight(Kg)	: 50,00
Paket Ölç./Pkg Dim(mm)	: 900 x 1030 x 650
Fiyat / Price €	: 525,00 €



Setaltı Tezgah / Under Counter Table

Kod / Code	: 81580200701
Model No	: KAD - 12090
Boyut / Size (mm)	: 1200 x 810 x 550
Hacim / Volume(m ³)	: 0,72
Ağırlık / Weight(Kg)	: 60,00
Paket Ölç./Pkg Dim(mm)	: 1300 x 1030 x 650
Fiyat / Price €	: 600,00 €





GAZLI KUZİNELER GAS RANGE WITH OVEN



KOD Code	MODEL Model	GİRİŞ Inlet	MODÜL Gross (m ²)	GÜÇ Power (kw)	ENERJİ Energy	EBAT Size (cm)	FİYAT PRICE €
801180801	KKFE-101	3/4"	1	40,00	LPG-NG/E	100 x 100 x 85	2.500,00



PASTA BÖREK FIRINLARI PASTRY & PIE OVENS



KOD Code	MODEL Model	GİRİŞ Inlet	GÜÇ Power (kw)	ENERJİ Energy	EBAT Size (cm)	FİYAT PRICE €
805101202	KPBF-9090	1/2"	18,00	LPG-NG	100 x 100 x 160	2.250,00



ELEKTRİKLİ YER OCAĞI GROUND RANGE ELECTRICAL



KOD Code	MODEL Model	GİRİŞ Inlet	GÜÇ Power (kw)	ENERJİ Energy	EBAT Size (cm)	FİYAT PRICE €
801650702	KYE	400 / 50-60HZ	5,00	ELEKTRİK	600 x 700 x 500	970,00



GAZLI YER OCAĞI GROUND RANGE WITH GAS



KOD Code	MODEL Model	GİRİŞ Inlet	GÜÇ Power (kw)	ENERJİ Energy	EBAT Size (cm)	FİYAT PRICE €
801650703	KYG	1/2"	20,00	LPG	600x700x500	825,00
801650701	KNG	1/2"	20,00	NG	600x700x500	825,00
801650704	KYG	1/2"	30,00	LPG	820*700*500	900,00
810650705	KNG	1/2"	30,00	NG	820*700*500	900,00



KÖMÜRLÜ IZGARA DAVLUMBAZI HOOD WITH COAL GRILL

KOD Code	EBAT Size (mm)	AĞIRLIK Weight (kg)	FİYAT PRICE €
60306102	1000 x 650 x 1150	32,00	691,88
60306152	1500 x 650 x 1150	42,00	804,38
60306202	2000 x 650 x 1150	52,00	916,88
60306252	2500 x 650 x 1150	65,00	1.068,75



KÖMÜRLÜ IZGARA COAL GRILL

KOD Code	EBAT Size (mm)	AĞIRLIK Weight (kg)	FİYAT PRICE €
801092100	920 x 500 x 250	88,00	646,88 €
801142100	1420 x 500 x 250	116,00	821,25 €
801192100	1920 x 500 x 250	144	1.181,25 €
801242100	2420 x 500 x 250	165	1.518,75 €



KÖMÜRLÜ IZGARA MODÜLÜ COAL GRILL MODULE

KOD Code	TİP Type	AĞIRLIK Weight (kg)	FİYAT PRICE €
805532200	Yuvarlak / Round - 500	20,00	281,25
805532201	V Tipi / V Type - 500	18,00	225,00

Soğutma Üniteleri

Cold Units



www.kayalarmutfak.com.tr

444 5 957



60 mm izolasyonlu duvarlar

Insulation Polyurethane,60mm

Düşük Enerji tüketimi için **Low Energy Consumption**

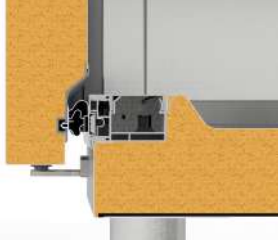

Ergonomik kapı tasarımı

Ergonomic Door Design

Comfortable and changeable door



Kolay uygulanabilir kilit aparatı

Easy applicable lock set

Kolay montaj



Maksimum soğutma verimi

Maximum cooling performance

Yuvarlatılmış Köşeler





DİKEY TİP BUZDOLABI (Fanlı) UPRIGHT REFRIGERATORS (with Fan)

KOD Code	SOĞUTMA GAZI Cooling Gas	EBAT Size (mm)	PAKET ÖLÇÜSÜ Package Dimen.. (mm)	ÇALIŞMA ISI ARALIĞI C° Work Temp	KAPASİTE Capacity	GÜÇ Power	VOLTAJ Voltage	FİYAT PRICE €
208720001200	R290	700 x 830 x 2050	750 x 885 x 2125	+2/+8 C°	604,00 Lt.	0,30 kW	220 V	1.878,75
208420012200	R290	1400 x 830 x 2050	1450 x 885 x 2125	+2/+8 C°	1334,00 Lt.	0,50 kW	220 V	2.722,50
208720001300	R290	700 x 830 x 2050	750 x 885 x 2125	-18/-22 C°	604,00 Lt.	0,50 kW	220 V	2.272,50
208420012400	R290	1400 x 830 x 2050	1450 x 885 x 2125	-18/-22 C°	1334,00 Lt.	0,70 kW	220 V	3.172,50

Option 170 € 115V / 60 Hz



DİKEY TİP BUZDOLABI CAM KAPILI
UPRIGHT REFRIGERATORS GLASS DOOR

KOD Code	SOĞUTMA GAZI Cooling Gas	EBAT Size (mm)	PAKET ÖLÇÜSÜ Package Dimen.. (mm)	ÇALIŞMA ISI ARALIĞI C° Work Temp	KAPASİTE Capacity	GÜÇ Power	VOLTAJ Voltage	FİYAT PRICE €
208720008200	R290	700 x 830 x 2050	750 x 885 x 2125	+2/+8 C°	604,00 Lt.	0,30 kW	220 V	2.272,50
208420088200	R290	1400 x 830 x 2050	1450 x 885 x 2125	+2/+8 C°	1334,00 Lt.	0,50 kW	220 V	3.060,00
208720008400	R290	700 x 830 x 2050	750 x 885 x 2125	-18/-22 C°	604,00 Lt.	0,50 kW	220 V	2.891,25
208420088101	R290	1400 x 830 x 2050	1450 x 885 x 2125	-18/-22 C°	1334,00 Lt.	0,70 kW	220 V	3.720,00

Option 170 € 115V / 60 Hz

Soğutucular / Cold Units



DİKEY TİP BUZDOLABI (Statik) UPRIGHT REFRIGERATORS (Static)

KOD Code	SOĞUTMA GAZI Cooling Gas	EBAT Size (mm)	PAKET ÖLÇÜSÜ Package Dimen.. (mm)	ÇALIŞMA ISI ARALIĞI C° Work Temp	KAPASİTE Capacity	GÜÇ Power (kW)	VOLTAJ Voltage	FİYAT PRICE €
208720001401	R290	700 x 830 x 2050	750 x 885 x 2125	+2/+8 C°	604,00 Lt.	0,30	220 V	2.400,00

Option 170 € 115V / 60 Hz

DİKEY TİP BUZDOLABI PASTA KİTLİ UPRIGHT REFRIGERATORS WITH PASTRY KİT

KOD Code	SOĞUTMA GAZI Cooling Gas	EBAT Size (mm)	PAKET ÖLÇÜSÜ Package Dimen.. (mm)	ÇALIŞMA ISI ARALIĞI C° Work Temp	KAPASİTE Capacity	GÜÇ Power (kW)	VOLTAJ Voltage	FİYAT PRICE €
208720001901	R290	700 x 830 x 2050	750 x 885 x 2125	+2/+8 C°	604,00 Lt.	0,30	220 V	1.700,00
208420012901	R290	1400 x 830 x 2050	1450 x 885 x 2125	+2/+8 C°	1334,00 Lt.	0,50	220 V	2.790,00
208720001601	R290	700 x 830 x 2050	750 x 885 x 2125	-18/-22 C°	604,00 Lt.	0,30	220 V	2.000,00
208420012601	R290	1400 x 830 x 2050	1450 x 885 x 2125	-18/-22 C°	1334,00 Lt.	0,50	220 V	3.150,00

Option 170 € 115V / 60 Hz

60 mm izolasyonlu duvarlar Insulation Polyurethane,60mm

Düşük Enerji tüketimi için Low Energy Consumption

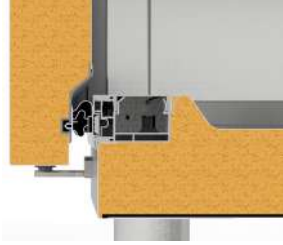

Ergonomik kapı tasarımı Ergonomic Door Design

Comfortable and changeable door



Kolay uygulanabilir kilit aparatı Easy applicable lock set

Kolay montaj



Maksimum soğutma verimi Maximum cooling performance

Yuvarlatılmış Köşeler



* Çevre dostu soğutucu gaz R-134 A kullanıyoruz.

* NEGATİF BUZDOLAPLARIMIZDA (DERİN DONDURUCULARDA) çevre dostu soğutucu gaz R-404 A kullanıyoruz.

* TÜM BUZDOLABI VE DERİN DONDURUCU MODELLERİMİZ dış kapalı ortam sıcaklığının 43° C dereceye ulaşabildiği tropikal iklim koşullarında çalışmaya uygundur.







* We use ozone friendly cooling gas R-134 A in our POSITIVE REFRIGERATORS.

* We use ozone friendly cooling gas R-404 A in our NEGATIVE REFRIGERATORS (DEEP FREEZERS).

* OUR ALL REFRIGERATOR AND DEEP FREEZER MODELS are suitable to operate in outer closed environment until 43° C degree in tropical climate conditions



TEZGAH TİPİ BUZDOLABI COUNTER TYPE REFRIGERATORS

KOD Code	SOĞUTMA GAZI Cooling Gas	ÇALIŞMA ARALIĞI Work Temp	KAPASİTE Capacity (Lt.)	GÜÇ Power (kW)	VOLTAJ Voltage	EBAT Size (mm)	PAKET ÖLÇÜSÜ Package Dimen. (mm)	FİYAT PRICE €
 206480011210	R290	+2, +8°C	234,00	0,30	230V 1+N 50/60Hz	1400x600x850	1450x650x980	1.822,50
 206880111210	R290	+2, +8°C	395,00	0,39	230V 1+N 50/60Hz	1886x600x850	1936x650x980	1.991,25
 206281111210	R290	+2, +8°C	550,00	0,44	230V 1+N 50/60Hz	2372x600x850	2422x650x980	2.272,50
 207480011210	R290	+2, +8°C	281,00	0,30	230V 1+N 50/60Hz	1400x700x850	1450x750x980	1.878,75
 207880111210	R290	+2, +8°C	475,00	0,39	230V 1+N 50/60Hz	1886x700x850	1936x750x980	2.047,50
 207281111210	R290	+2, +8°C	632,00	0,44	230V 1+N 50/60Hz	2372x700x850	2422x750x980	2.441,25
 206480011410	R290	0, -18°C	234,00	0,50	230V 1+N -50/60Hz	1400x600x850	1450x650x980	2.160,00
 206880111410	R290	0, -18°C	395,00	0,60	230V 1+N -50/60Hz	1886x600x850	1936x650x980	2.497,50
 207480011410	R290	0, -18°C	281,00	0,60	230V 1+N -50/60Hz	1400x700x850	1450x750x980	2.272,50
 207880111410	R290	0, -18°C	475,00	0,60	230V 1+N -50/60Hz	1886x700x850	1936x750x980	2.610,00

Option 170 € 115V / 60 Hz

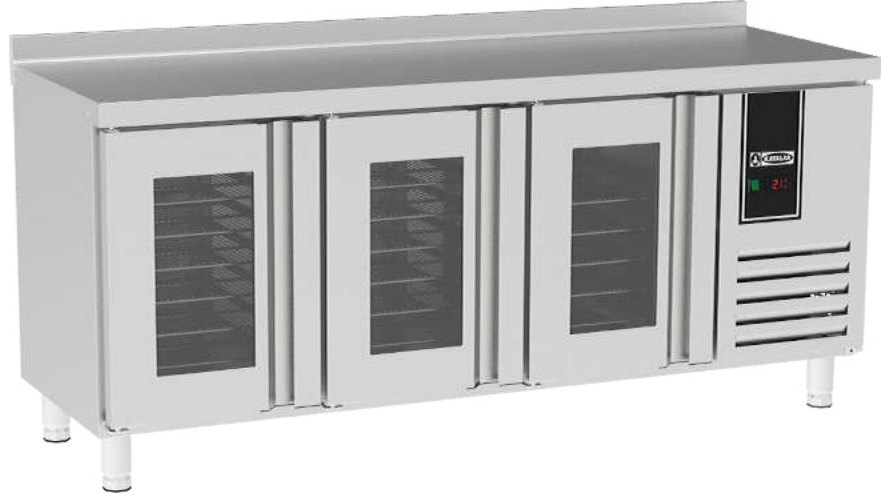

TEZGAH TİPİ BUZDOLABI CAM KAPILI
COUNTER TYPE REFRIGERATORS GLASS DOOR

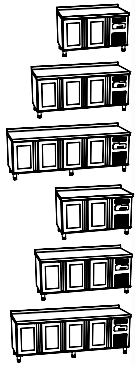











KOD Code	SOĞUTMA GAZI Cooling Gas	ÇALIŞMA ARALIĞI Work Temp	KAPASİTE Capacity (Lt.)	GÜÇ Power (kW)	VOLTAJ Voltage	EBAT Size (mm)	PAKET ÖLÇÜSÜ Package Dimen.. (mm)	FİYAT PRICE €
206480088210	R290	+2, +8 °C	234,00	0,31	230V 1+N 50/60Hz	1400 x 600 x 850	1450 x 650 x 980	1.991,25
206880888210	R290	+2, +8 °C	395,00	0,41	230V 1+N 50/60Hz	1886 x 600 x 850	1936 x 650 x 980	2.272,50
206288888210	R290	+2, +8 °C	550,00	0,47	230V 1+N 50/60Hz	2372 x 600 x 850	2422 x 650 x 980	2.835,00
207480088210	R290	+2, +8 °C	281,00	0,31	230V 1+N 50/60Hz	1400 x 700 x 850	1450 x 750 x 980	2.047,50
207880888210	R290	+2, +8 °C	475,00	0,41	230V 1+N 50/60Hz	1886 x 700 x 850	1936 x 750 x 980	2.328,75
207288888210	R290	+2, +8 °C	632,00	0,47	230V 1+N 50/60Hz	2372 x 700 x 850	2422 x 750 x 980	3.116,25

Option 170 € 115V / 60 Hz



TEZGAH TİPİ BUZDOLABI ÇEKMECELİ COUNTER TYPE REFRIGERATORS WITH DRAWERS

KOD Code	SOĞUTMA GAZI Cooling Gas	ÇALIŞMA ARALIĞI Work Temp C°	ÇEKMECE SAYISI Number Of Drawer	KAPASİTE Capacity (Lt.)	GÜÇ Power (kW)	VOLTAJ Voltage	EBAT Size (mm)	PAKET ÖLÇÜSÜ Package Dimen. (mm)	FİYAT PRICE €
 206480055210	R290	+2, +8°C	4	234,00	0,30	230V 1+N 50/60Hz	1400x600x850	1450x650x980	2.272,50
 206880555210	R290	+2, +8°C	6	395,00	0,39	230V 1+N 50/60Hz	1886x600x850	1936x650x980	2.649,38
 206285555210	R290	+2, +8°C	8	550,00	0,44	230V 1+N 50/60Hz	2372x600x850	2422x650x980	3.228,75
 207480055210	R290	+2, +8°C	4	281,00	0,30	230V 1+N 50/60Hz	1400x700x850	1450x750x980	2.385,00
 207880555210	R290	+2, +8°C	6	475,00	0,39	230V 1+N 50/60Hz	1886x700x850	1936x750x980	2.722,50
 207285555210	R290	+2, +8°C	8	632,00	0,44	230V 1+N 50/60Hz	2372x700x850	2422x750x980	3.566,25
 206480053410	R290	0, -18°C	2	234,00	0,30	230V 1+N 50/60Hz	1400x600x850	1450x650x980	2.553,75
 206880553410	R290	0, -18°C	4	395,00	0,39	230V 1+N 50/60Hz	1886x600x850	1936x650x980	2.801,25
 207480053410	R290	0, -18°C	2	281,00	0,30	230V 1+N 50/60Hz	1400x700x850	1450x750x980	2.666,25
 207880551210	R290	0, -18°C	4	475,00	0,39	230V 1+N 50/60Hz	1886x700x850	1936x750x980	2.947,50

Option 170 € 115V / 60 Hz



PİZZA & SALATA HAZIRLIK BUZDOLABI

PIZZA & SALAD PREPARATION REFRIGERATOR

KOD Code	SOĞUTMA GAZI Cooling Gas	ÇALIŞMA ARALIĞI Work Temp C°	KAPASİTE Capacity (Lt.)	GÜÇ Power (kW)	VOLTAJ Voltage	EBAT Size (mm)	PAKET ÖLÇÜSÜ Package Dimen.. (mm)	FİYAT PRICE €
207480011610	R290	+2, +8°C	281,00	0,59	230V 1+N - 50/60Hz	1400x700x850 / 1350	1450x750x1435	2.497,50
207880111610	R290	+2, +8°C	475,00	0,59	230V 1+N - 50/60Hz	1886x700x850 / 1350	1900x750x1435	2.722,50

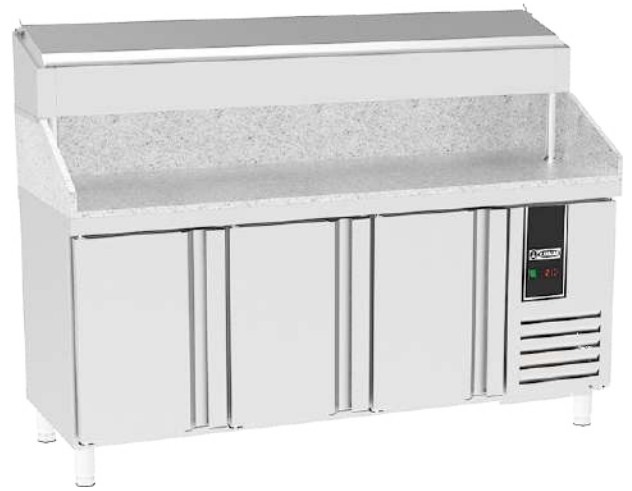

PİZZA & SALATA HAZIRLIK BUZDOLABI GRANİT TABLALI

PIZZA & SALAD PREPARATION REFRIGERATOR W.GRANITE TOP

KOD Code	SOĞUTMA GAZI Cooling Gas	ÇALIŞMA ARALIĞI Work Temp C°	KAPASİTE Capacity (Lt.)	GÜÇ Power (kW)	VOLTAJ Voltage	EBAT Size (mm)	PAKET ÖLÇÜSÜ Package Dimen.. (mm)	FİYAT PRICE €
207480011640	R290	+2, +8°C	281,00	0,59	230V 1+N - 50/60Hz	1400x700x850 / 1350	1450x750x1435	3.200,00
207880111640	R290	+2, +8°C	475,00	0,59	230V 1+N - 50/60Hz	1886x700x850 / 1350	1936x750x1435	3.648,00



Option 170 € 115V / 60 Hz

Soğutucular / Cold Units

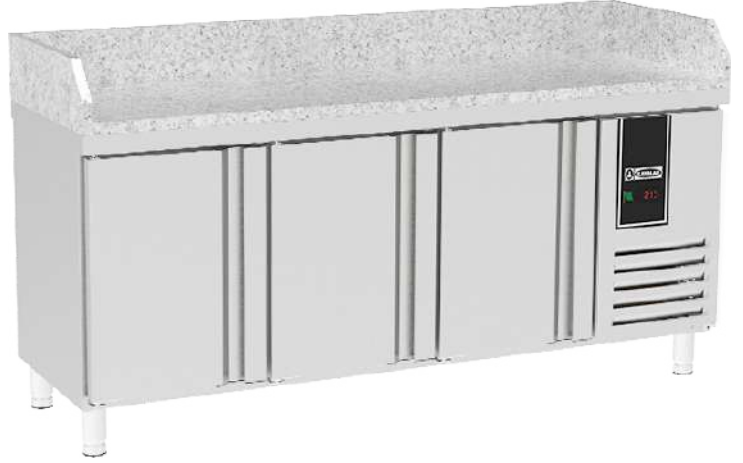

HAMUR HAZIRLIK BUZDOLABI GRANİT TABLALI

DOUGH PREPARATION REFRIGERATOR WITH GRANITE TOP

KOD Code	SOĞUTMA GAZI Cooling Gas	ÇALIŞMA ARALIĞI Work Temp C°	KAPASİTE Capacity (Lt.)	GÜÇ Power (kW)	VOLTAJ Voltage	EBAT Size (mm)	PAKET ÖLÇÜSÜ Package Dimen. (mm)	FİYAT PRICE €
207480011240	R290	+2, +8°C	281,00	0,30	230V 1+N - 50/60Hz	1400x700x850 / 1090	1450x750x1150	2.497,50
207880111240	R290	+2, +8°C	475,00	0,39	230V 1+N - 50/60Hz	1886x700x850 / 1090	1936x750x1150	2.722,50
207281111240	R290	+2, +8°C	632,00	0,44	230V 1+N - 50/60Hz	2372x700x850 / 1090	2422x750x1150	3.060,00



SET ALTI BUZDOLABI

UNDER COUNTER REFRIGERATORS

KOD Code	SOĞUTMA GAZI Cooling Gas	ÇALIŞMA ARALIĞI Work Temp	KAPASİTE Capacity (Lt.)	GÜÇ Power (kW)	VOLTAJ Voltage	EBAT Size (mm)	PAKET ÖLÇÜSÜ Package Dimen.. (mm)	FİYAT PRICE €
207460077211	R290	-18, -22°C	175,00	0,26	230V 1+N 50/60Hz	1400 x 700 x 575	1450 x 750 x 770	2.710,00
207460077210	R290	+2, +8°C	175,00	0,26	230V 1+N 50/60Hz	1400 x 700 x 575	1450 x 750 x 770	2.047,50
207860777211	R290	-18, -22°C	260,00	0,30	230V 1+N 50/60Hz	1886 x 700 x 575	1936 x 750 x 770	3.300,00
207860777210	R290	+2, +8°C	260,00	0,30	230V 1+N 50/60Hz	1886 x 700 x 575	1936 x 750 x 770	2.385,00
207267777210	R290	+2, +8°C	340,00	0,35	230V 1+N 50/60Hz	2372 x 700 x 575	2422 x 750 x 770	2.835,00

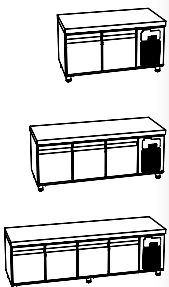

Option 170 € 115V / 60 Hz

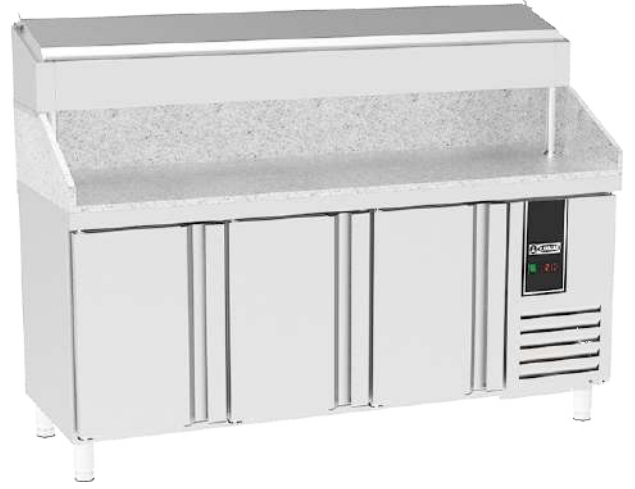

**PİZZA & SALATA HAZIRLIK BUZDOLABI
GRANİT TABLALI (40X60)**

**PIZZA & SALAD PREPARATION REFRIGERATOR
W.GRANITE TOP (40X60)**

KOD Code	SOĞUTMA GAZI Cooling Gas	ÇALIŞMA ARALIĞI Work Temp		GÜÇ Power (kW)	VOLTAJ Voltage	EBAT Size (mm)	PAKET ÖLÇÜSÜ Package Dimen.. (mm)	FİYAT PRICE €
209980033640	R290	+2, +8°C	380,00	0,59	230V 1+N 50/60Hz	1550 x 800 x 1350	1600 x 850 x 1400	3.397,50
209080333640	R290	+2, +8°C	615,00	0,59	230V 1+N 50/60Hz	2100 x 800 x 1350	2150 x 850 x 1400	4.072,50
209083333640	R290	+2, +8°C	850,00	0,70	230V 1+N 50/60Hz	2650 x 800 x 1350	2700 x 850 x 1400	4.635,00

NOT: Gastronom kaplar fiyata dahil değildir. **Gastronom cups are not included in the price.**



TEZGAH TİPİ BUZDOLABI (40X60) STATİK

COUNTER TYPE REFRIGERATORS (40X60) STATIC

KOD Code	SOĞUTMA GAZI Cooling Gas	ÇALIŞMA ARALIĞI Work Temp		GÜÇ Power (kW)	VOLTAJ Voltage	EBAT Size (mm)	PAKET ÖLÇÜSÜ Package Dimen.. (mm)	FİYAT PRICE €
209980033210	R290	+2, +8°C	380,00	0,30	230V 1+N 50/60Hz	1550 x 800 x 850	1600 x 850 x 900	2.700,00
209080333210	R290	+2, +8°C	615,00	0,39	230V 1+N 50/60Hz	2100 x 800 x 850	2150 x 850 x 900	3.262,50
209083333210	R290	+2, +8°C	850,00	0,50	230V 1+N 50/60Hz	2650 x 800 x 850	2700 x 850 x 900	3.825,00

Option 170 € 115V / 60 Hz

Soğutucular / Cold Units



TEZGAH TİPİ BUZDOLABI (40X60)
COUNTER TYPE REFRIGERATORS (40X60)

KOD Code	SOĞUTMA GAZI Cooling Gas	ÇALIŞMA ARALIĞI Work Temp	KAPASİTE Capacity (Lt.)	GÜÇ Power (kW)	VOLTAJ Voltage	EBAT Size (mm)	PAKET ÖLÇÜSÜ Package Dimen. (mm)	FİYAT PRICE €
209980033210	R290	+2, +8 °C	380,00	0,30	230V 1+N 50/60Hz	1550x800x850	1600x850x900	3.060,00
209980033410	R290	-18, -22 °C	380,00	0,35	230V 1+N 50/60Hz	1550x800x850	1600x850x900	3.400,00
209080333210	R290	+2, +8 °C	615,00	0,39	230V 1+N 50/60Hz	2100x800x850	2150x850x900	3.622,50
209080333410	R290	-18, -22 °C	615,00	0,45	230V 1+N 50/60Hz	2100x800x850	2150x850x900	4.022,00
209083333210	R290	+2, +8 °C	850,00	0,44	230V 1+N 50/60Hz	2650x800x850	2700x850x900	4.185,00

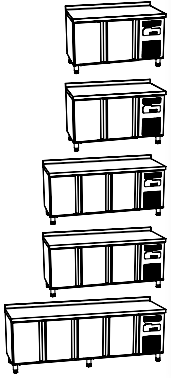

Option 170 € 115V / 60 Hz



SET ÜSTÜ SALAT BAR
COUNTER TOP SALAD BAR

KOD Code	ÇALIŞMA ARALIĞI Work Temp C°	KAPASİTE Capacity (Lt.)	GÜÇ Power (kW)	VOLTAJ Voltage	EBAT Size (mm)	PAKET ÖLÇÜSÜ Package Dimen.. (mm)	FİYAT PRICE €
99050390026	+2, +8 °C	234,00	0,20	230V 1+N - 50/60Hz	1400 x 350 x 450	1450 x 400 x 500	1.350,00
99050390025	+2, +8 °C	281,00	0,20	230V 1+N - 50/60Hz	1886 x 350 x 450	1900 x 400 x 500	1.650,00

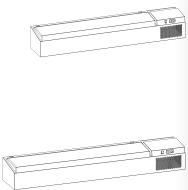

Option 170 € 115V / 60 Hz

KOD Code	AÇIKLAMA DESCRIPTION	FİYAT PRICE (€)
10040910002	Refrigerator Door Switch	5,00
YM003000004	GN 1/1 (3x1/3) Drawer Group	390,00
YM003000003	GN 1/1 (2x1/2) Drawer Group	310,00
YM003000002	YP Counter Type Standard Door	120,00
YM003000102	YP Counter Type Glass Door	150,00
YM003000003	Under Counter Standard Door	360,00
DM003000001	Upright Standard Door	300,00
DM003000101	Upright Standard Glass Door	(-2/+8 C°) 300,00 € (-18/-22 C°) 550,00 €
DM011000001	Lock Set	40,00
D0010110066	Pastry Kit Slide	20,00

KOD Code	AÇIKLAMA DESCRIPTION	FİYAT PRICE (€)
10030510020	2 Wheels Kit Set With Brake	65,00
10030510021	2 Wheels Kit Set Without Brake	65,00
DM126000002	Cooling Group DP-820	600,00
DM126000001	Cooling Group DP-810	600,00
YM126000005	Cooling Group YP - 673	600,00
YM126000006	Cooling Group YP - 674	900,00
YM126000001	Cooling Group YP - 672	600,00
10030520101	YP 600 Stainless Steel Wire Shelf	9,00
10030520100	DP Stainless Steel Wire Shelf	11,00
10030520102	YP 700 Stainless Steel Wire Shelf	9,00
10020210103	Refrigerator Door Seal DP	40,00
10020210100	Refrigerator Door Seal YPS	25,00
10020210105	Refrigerator Door Seal YP	30,00
10040110100	Digital Indicator With Single Probe	100,00
10040110101	Digital Indicator With Double Probe	110,00

Çalışma Tezgahları

Work Tables



www.kayalarmutfak.com.tr

444 5 957





ÇALIŞMA TEZGAHI TABAN RAFSIZ
WORK TABLE WITHOUT BOTTOM SHELF



Opsiyonel Olarak Demonte
Optional Disassembled

KOD Code	EBAT Size (mm)			HACİM VOLUME (m ³)	FİYAT PRICE €
	L	W	H		
70610801000000	1000	600	850	0,5668	328,50
70611801000000	1100	600	850	0,6229	343,13
70612801000000	1200	600	850	0,6791	362,25
70613801000000	1300	600	850	0,7352	375,75
70614801000000	1400	600	850	0,7913	405,00
70615801000000	1500	600	850	0,8474	416,25
70616801000000	1600	600	850	0,9035	430,88
70617801000000	1700	600	850	0,9597	461,25
70618801000000	1800	600	850	1,0158	477,00
70619801000000	1900	600	850	1,0719	491,63

KOD Code	EBAT Size (mm)			HACİM VOLUME (m ³)	FİYAT PRICE €
	L	W	H		
70710801000000	1000	700	850	0,6597	346,50
70711801000000	1100	700	850	0,7250	369,00
70712801000000	1200	700	850	0,7903	390,38
70713801000000	1300	700	850	0,8556	405,00
70714801000000	1400	700	850	0,9210	426,38
70715801000000	1500	700	850	0,9863	447,75
70716801000000	1600	700	850	1,0516	461,25
70717801000000	1700	700	850	1,1169	490,50
70718801000000	1800	700	850	1,1822	513,00
70719801000000	1900	700	850	1,2476	527,63



ÇALIŞMA TEZGAHI TABAN RAFLI
WORK TABLE WITH BOTTOM SHELF



Opsiyonel Olarak Demonte
Optional Disassembled

KOD Code	EBAT Size (mm)			HACİM VOLUME (m ³)	FİYAT PRICE €
	L	W	H		
70610801100000	1000	600	850	0,5668	369,00
70611801100000	1100	600	850	0,6229	397,13
70612801100000	1200	600	850	0,6791	418,50
70613801100000	1300	600	850	0,7352	439,88
70614801100000	1400	600	850	0,7913	468,00
70615801100000	1500	600	850	0,8474	491,63
70616801100000	1600	600	850	0,9035	519,75
70617801100000	1700	600	850	0,9597	540,00
70618801100000	1800	600	850	1,0158	562,50
70619801100000	1900	600	850	1,0719	592,88

KOD Code	EBAT Size (mm)			HACİM VOLUME (m ³)	FİYAT PRICE €
	L	W	H		
70710801100000	1000	700	850	0,6597	398,25
70711801100000	1100	700	850	0,7250	426,38
70712801100000	1200	700	850	0,7903	454,50
70713801100000	1300	700	850	0,8556	477,00
70714801100000	1400	700	850	0,9210	506,25
70715801100000	1500	700	850	0,9863	534,38
70716801100000	1600	700	850	1,0516	562,50
70717801100000	1700	700	850	1,1169	585,00
70718801100000	1800	700	850	1,1822	614,25
70719801100000	1900	700	850	1,2476	642,38

Çalışma Tezgahları / Work Tables



Opsiyonel Olarak Demonte
Optional Disassembled

ÇALIŞMA TEZGAHI TABAN VE ARA RAFLI WORK TABLE WITH BOTTOM AND MIDDLE SHELF

KOD Code	EBAT Size (mm)			HACİM VOLUME (m ³)	FİYAT PRICE €
	L	W	H		
70610801200000	1000	600	850	0,5668	396,00
70611801200000	1100	600	850	0,6229	472,50
70612801200000	1200	600	850	0,6791	506,25
70613801200000	1300	600	850	0,7352	540,00
70614801200000	1400	600	850	0,7913	567,00
70615801200000	1500	600	850	0,8474	600,75
70616801200000	1600	600	850	0,9035	634,50
70617801200000	1700	600	850	0,9597	668,25
70618801200000	1800	600	850	1,0158	695,25
70619801200000	1900	600	850	1,0719	729,00

KOD Code	EBAT Size (mm)			HACİM VOLUME (m ³)	FİYAT PRICE €
	L	W	H		
70710801200000	1000	700	850	0,6597	479,25
70711801200000	1100	700	850	0,7250	519,75
70712801200000	1200	700	850	0,7903	553,50
70713801200000	1300	700	850	0,8556	587,25
70714801200000	1400	700	850	0,9210	621,00
70715801200000	1500	700	850	0,9863	654,75
70716801200000	1600	700	850	1,0516	688,50
70717801200000	1700	700	850	1,1169	729,00
70718801200000	1800	700	850	1,1822	762,75
70719801200000	1900	700	850	1,2476	796,50



Opsiyonel Olarak Demonte
Optional Disassembled

TEK ÇEKMECELİ ÇALIŞMA TEZGAHI TABAN RAFLI WORK TABLE WITH BOTTOM SHELF AND SINGLE DRAWER

KOD Code	EBAT Size (mm)			HACİM VOLUME (m ³)	FİYAT PRICE €
	L	W	H		
70610801105000	1000	600	850	0,5668	560,25
70611801105000	1100	600	850	0,6229	580,50
70612801105000	1200	600	850	0,6791	607,50
70613801105000	1300	600	850	0,7352	627,75
70614801105000	1400	600	850	0,7913	648,00
70615801105000	1500	600	850	0,8474	668,25
70616801105000	1600	600	850	0,9035	688,50
70617801105000	1700	600	850	0,9597	715,50
70618801105000	1800	600	850	1,0158	735,75
70619801105000	1900	600	850	1,0719	756,00

KOD Code	EBAT Size (mm)			HACİM VOLUME (m ³)	FİYAT PRICE €
	L	W	H		
70710801105000	1000	700	850	0,65973	587,25
70711801105000	1100	700	850	0,7250	614,25
70712801105000	1200	700	850	0,7903	634,50
70713801105000	1300	700	850	0,8556	661,50
70714801105000	1400	700	850	0,92101	681,75
70715801105000	1500	700	850	0,9863	708,75
70716801105000	1600	700	850	1,0516	729,00
70717801105000	1700	700	850	1,1169	756,00
70718801105000	1800	700	850	1,1822	783,00
70719801105000	1900	700	850	1,2476	803,25



HAREKETLİ ÇALIŞMA TEZGAHI TABAN RAFLI
MOBILE WORK TABLE WITH BOTTOM SHELF

KOD Code	EBAT Size (mm)			HACİM VOLUME (m ³)	FİYAT PRICE €
	L	W	H		
70610800110000	1000	600	850	0,5298	433,13
70611800110000	1100	600	850	0,5823	455,63
70612800110000	1200	600	850	0,6348	483,75
70613800110000	1300	600	850	0,6872	506,25
70614800110000	1400	600	850	0,7397	528,75
70615800110000	1500	600	850	0,7921	556,88
70616800110000	1600	600	850	0,8446	579,38
70617800110000	1700	600	850	0,8971	607,50
70618800110000	1800	600	850	0,9495	630,00
70619800110000	1900	600	850	1,0020	652,50

HAREKETLİ ÇALIŞMA TEZGAHI TABAN RAFLI

KOD Code	EBAT Size (mm)			HACİM VOLUME (m ³)	FİYAT PRICE €
	L	W	H		
70710800110000	1000	700	850	0,6167	461,25
70711800110000	1100	700	850	0,67776	489,38
70712800110000	1200	700	850	0,7388	517,50
70713800110000	1300	700	850	0,7998	540,00
70714800110000	1400	700	850	0,8609	568,13
70715800110000	1500	700	850	0,9220	596,25
70716800110000	1600	700	850	0,9830	624,38
70717800110000	1700	700	850	1,0441	649,13
70718800110000	1800	700	850	1,1051	675,00
70719800110000	1900	700	850	1,1662	703,13



HAREKETLİ ÇALIŞMA TEZGAHI TABAN VE ARA RAFLI
MOBILE WORK TABLE WITH BOTTOM AND MIDDLE SHELF

KOD Code	EBAT Size (mm)			HACİM VOLUME (m ³)	FİYAT PRICE €
	L	W	H		
70610800210000	1000	600	850	0,5298	528,75
70611800210000	1100	600	850	0,5823	562,50
70612800210000	1200	600	850	0,6348	596,25
70613800210000	1300	600	850	0,6872	630,00
70614800210000	1400	600	850	0,7397	663,75
70615800210000	1500	600	850	0,7921	697,50
70616800210000	1600	600	850	0,8446	731,25
70617800210000	1700	600	850	0,8971	765,00
70618800210000	1800	600	850	0,9495	798,75
70619800210000	1900	600	850	1,0020	832,50

KOD Code	EBAT Size (mm)			HACİM VOLUME (m ³)	FİYAT PRICE €
	L	W	H		
70710800210000	1000	700	850	0,6167	568,13
70711800210000	1100	700	850	0,67776	607,50
70712800210000	1200	700	850	0,73882	646,88
70713800210000	1300	700	850	0,79988	680,63
70714800210000	1400	700	850	0,86094	720,00
70715800210000	1500	700	850	0,92200	753,75
70716800210000	1600	700	850	0,98306	793,13
70717800210000	1700	700	850	1,04412	832,50
70718800210000	1800	700	850	1,1051	866,25
70719800210000	1900	700	850	1,1662	905,63

Çalışma Tezgahları / Work Tables



DOLAPLI ÇALIŞMA TEZGAHI ÇARPMA KAPILI ARA RAFLI
WORK TABLE WITH CUPBOARD WITH MIDDLE SHELF

KOD Code	EBAT Size (mm)			HACİM VOLUME (m ³)	FİYAT PRICE €
	L	W	H		
70610801420000	1000	600	850	0,5668	670,50
70611801420000	1100	600	850	0,6229	716,63
70612801420000	1200	600	850	0,6791	759,38
70613801420000	1300	600	850	0,7352	844,88
70614801420000	1400	600	850	0,7913	853,88
70615801420000	1500	600	850	0,8474	898,88
70616801420000	1600	600	850	0,9035	945,00
70617801420000	1700	600	850	0,9597	1.010,25
70618801420000	1800	600	850	1,0158	1.046,25
70619801420000	1900	600	850	1,0719	1.091,25

KOD Code	EBAT Size (mm)			HACİM VOLUME (m ³)	FİYAT PRICE €
	L	W	H		
70710801420000	1000	700	850	0,6597	717,75
70711801420000	1100	700	850	0,7250	767,25
70712801420000	1200	700	850	0,7903	813,38
70713801420000	1300	700	850	0,8556	902,25
70714801420000	1400	700	850	0,9210	913,50
70715801420000	1500	700	850	0,9863	961,88
70716801420000	1600	700	850	1,0516	1.010,25
70717801420000	1700	700	850	1,1169	1.069,88
70718801420000	1800	700	850	1,1822	1.118,25
70719801420000	1900	700	850	1,2476	1.167,75



DOLAPLI ÇALIŞMA TEZGAHI ARA RAFLI SÜRGÜ KAPILI
WORK TABLE WITH MIDDLE SHELF SLIDING DOORS

KOD Code	EBAT Size (mm)			HACİM VOLUME (m ³)	FİYAT PRICE €
	L	W	H		
70610801320000	1000	600	850	0,5668	708,75
70611801320000	1100	600	850	0,6229	759,38
70612801320000	1200	600	850	0,6791	804,38
70613801320000	1300	600	850	0,7352	855,00
70614801320000	1400	600	850	0,7913	900,00
70615801320000	1500	600	850	0,8474	950,63
70616801320000	1600	600	850	0,9035	995,63
70617801320000	1700	600	850	0,9597	1.057,50
70618801320000	1800	600	850	1,0158	1.102,50
70619801320000	1900	600	850	1,0719	1.147,50

KOD Code	EBAT Size (mm)			HACİM VOLUME (m ³)	FİYAT PRICE €
	L	W	H		
70710801320000	1000	700	850	0,6597	714,38
70711801320000	1100	700	850	0,7250	810,00
70712801320000	1200	700	850	0,7903	860,63
70713801320000	1300	700	850	0,8556	911,25
70714801320000	1400	700	850	0,9210	961,88
70715801320000	1500	700	850	0,9863	1.012,50
70716801320000	1600	700	850	1,0516	1.063,13
70717801320000	1700	700	850	1,1169	1.119,38
70718801320000	1800	700	850	1,1822	1.181,25
70719801320000	1900	700	850	1,2476	1.226,25



DOLAPLI ÇALIŞMA TEZGAHI BLOK ÇEKMECELİ

WORK TABLE DRAWERS, SLIDING DOORS AND INTERMEDIATE SHELF

KOD Code	EBAT Size (mm)			HACİM VOLUME (m ³)	FİYAT PRICE €
	L	W	H		
70615801326000	1500	600	850	0,8474	1.220,63
70616801326000	1600	600	850	0,9035	1.265,63
70617801326000	1700	600	850	0,9597	1.316,25
70618801326000	1800	600	850	1,0158	1.361,25
70619801326000	1900	600	850	1,0719	1.411,88

KOD Code	EBAT Size (mm)			HACİM VOLUME (m ³)	FİYAT PRICE €
	L	W	H		
70715801326000	1500	700	850	0,9863	1.293,75
70716801326000	1600	700	850	1,0516	1.344,38
70717801326000	1700	700	850	1,1169	1.395,00
70718801326000	1800	700	850	1,1822	1.445,63
70719801326000	1900	700	850	1,2476	1.496,25



ÇALIŞMA TEZGAHI 4 ÇEKMECELİ TABAN RAFSIZ

WORK TABLE WITH 4 DRAWERS

KOD Code	EBAT Size (mm)			HACİM VOLUME (m ³)	FİYAT PRICE €
	L	W	H		
70614801006000	1400	600	850	0,7913	888,75
70615801006000	1500	600	850	0,8474	905,63
70616801006000	1600	600	850	0,9035	922,50
70617801006000	1700	600	850	0,9597	939,38
70618801006000	1800	600	850	1,0158	956,25
70619801006000	1900	600	850	1,0719	978,75

KOD Code	EBAT Size (mm)			HACİM VOLUME (m ³)	FİYAT PRICE €
	L	W	H		
70714801006000	1400	700	850	0,9210	911,25
70715801006000	1500	700	850	0,9863	956,25
70716801006000	1600	700	850	1,0516	967,50
70717801006000	1700	700	850	1,1169	990,00
70718801006000	1800	700	850	1,1822	1.012,50
70719801006000	1900	700	850	1,2476	1.035,00

Çalışma Tezgahları / Work Tables



ÇALIŞMA TEZGAHI 4 ÇEKMECELİ TABAN RAFLI
WORK TABLE DRAWERS, BOTTOM SHELF

KOD Code	EBAT Size (mm)			HACİM VOLUME (m ³)	FİYAT PRICE €
	L	W	H		
70614801106000	1400	600	850	0,7913	933,75
70615801106000	1500	600	850	0,8474	950,63
70616801106000	1600	600	850	0,9035	973,13
70617801106000	1700	600	850	0,9597	995,63
70618801106000	1800	600	850	1,0158	1.023,75
70619801106000	1900	600	850	1,0719	1.046,25

KOD Code	EBAT Size (mm)			HACİM VOLUME (m ³)	FİYAT PRICE €
	L	W	H		
70714801106000	1400	700	850	984,38 €	984,38
70715801106000	1500	700	850	1.006,88 €	1.006,88
70716801106000	1600	700	850	1.029,38 €	1.029,38
70717801106000	1700	700	850	1.051,88 €	1.051,88
70718801106000	1800	700	850	1.085,63 €	1.085,63
70719801106000	1900	700	850	1.108,13 €	1.108,13



BLOK ÇEKMECE ÜNİTESİ
WORK TABLE WITH DRAWERS

KOD Code	EBAT Size (mm)	FİYAT PRICE €
70706801800000	600 x 600 x 850	731,25
70606801800000	700 x 600 x 850	843,75



DEPOLAMA DOLABI İKİ KAPILI 3 ARA RAFLI
PAN CUPBOARD WITH DOUBLE DOORS AND 3
INTERMEDIATE SHELVES

KOD Code	EBAT Size (mm)	FİYAT PRICE €
70612140000000	1200 x 600 x 1600	1.501,88
70712140000000	1200 x 700 x 1600	1.743,75



BIÇAK STERİLİZASYON DOLABI
KNIVES STERILIZATION CUPBOARD

KOD Code	KAPASİTE Capacity (Bıçak) (Knives)	GÜÇ Power (kW)	AĞIRLIK Weight (kg)	EBAT Size (cm)	FİYAT PRICE €
502431102	10	0,15	7	50 x 10 x 60	350,00
502931102	20	0,30	12	100 x 10 x 60	370,00

SICAKLIK DOLABI HOT CUPBOARD



KOD Code	EBAT Size (mm)	SICAKLIK TEMP. C°	GÜÇ Power (kW)	GERİLİM Voltage	FİYAT PRICE €
70610881320000	1000 x 600 x 850	30-90	1,5	220 V	1.051,88
70611881320000	1100 x 600 x 850	30-90	3,0	220 V	1.116,00
70612881320000	1200 x 600 x 850	30-90	3,0	220 V	1.181,25
70613881320000	1300 x 600 x 850	30-90	1,5	220 V	1.257,75
70614881320000	1400 x 600 x 850	30-90	1,5	220 V	1.323,00
70615881320000	1500 x 600 x 850	30-90	3,0	220 V	1.393,88
70616881320000	1600 x 600 x 850	30-90	3,0	220 V	1.464,75
70617881320000	1700 x 600 x 850	30-90	1,5	220 V	1.546,88
70618881320000	1800 x 600 x 850	30-90	1,5	220 V	1.617,75
70619881320000	1900 x 600 x 850	30-90	3,0	220 V	1.688,63
70710881320000	1000 x 700 x 850	30-90	1,5	220 V	1.116,00
70711881320000	1100 x 700 x 850	30-90	3,0	220 V	1.181,25
70712881320000	1200 x 700 x 850	30-90	3,0	220 V	1.263,38
70713881320000	1300 x 700 x 850	30-90	1,5	220 V	1.339,88
70714881320000	1400 x 700 x 850	30-90	1,5	220 V	1.410,75
70715881320000	1500 x 700 x 850	30-90	3,0	220 V	1.488,38
70716881320000	1600 x 700 x 850	30-90	3,0	220 V	1.559,25
70717881320000	1700 x 700 x 850	30-90	1,5	220 V	1.653,75
70718881320000	1800 x 700 x 850	30-90	1,5	220 V	1.724,63
70719881320000	1900 x 700 x 850	30-90	3,0	220 V	1.801,13

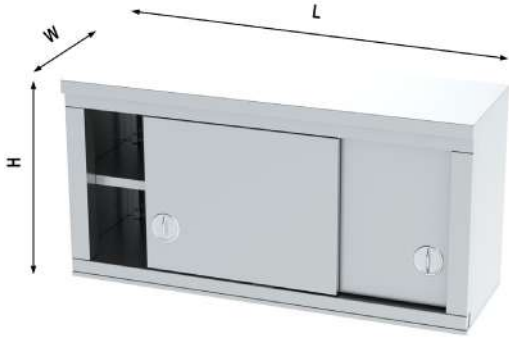

DUVAR DOLABI SÜRME KAPILI VE ARA RAFLI WALL CUPBOARD WITH SLIDING DOOR AND INTERMEDIATE SHELF

KOD Code	EBAT / Size (mm)	FİYAT PRICE €
70410610000000	1000 x 400 x 600	472,50
70412610000000	1200 x 400 x 600	543,38
70415610000000	1500 x 400 x 600	643,50
70419610000000	1900 x 400 x 600	790,88

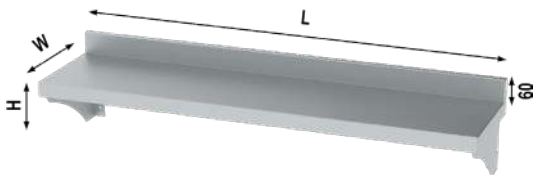

RAFI TEK SIRA WALL SHELF SINGLE - ROW

KOD Code	EBAT Size (mm)	FİYAT PRICE €
70310021000000	1000 x 300 x 40	153,00
70312021000000	1200 x 300 x 40	171,00
70314021000000	1400 x 300 x 40	189,00
70316021000000	1600 x 300 x 40	200,25
70319021000000	1900 x 300 x 40	219,38

Çalışma Tezgahları / Work Tables



SÜZME TEZGAHLARI

STRAINING TABLES

KOD Code	EBAT Size (mm)			HACİM VOLUME (m ³)	FİYAT PRICE €
	L	W	H		
70712809000003	1200	700	850	0,790	815,63 €
70714809000003	1400	700	850	0,921	922,50 €
70718809000003	1800	700	850	1,182	1.361,25 €



ÇÖP SIYIRMA TEZGAHLARI SOL HUNİLİ

WASTE PEELING TABLES WITH HOLE FROM LEFT

KOD Code	EBAT Size (mm)			HACİM VOLUME (m ³)	FİYAT PRICE €
	L	W	H		
40612831002000	1200	600	850	0,679	448,88
40616831002000	1600	600	850	0,904	523,13
40619831002000	1900	600	850	1,072	588,38
40712831002000	1200	700	850	0,790	483,75
40716831002000	1600	700	850	1,052	562,50
40719831002000	1900	700	850	1,248	630,00



ÇÖP SIYIRMA TEZGAHLARI SAĞ HUNİLİ

WASTE PEELING TABLES WITH HOLE FROM RIGHT

KOD Code	EBAT Size (mm)			HACİM VOLUME (m ³)	FİYAT PRICE €
	L	W	H		
40612831001000	1200	600	850	0,679	448,88
40616831001000	1600	600	850	0,904	523,13
40619831001000	1900	600	850	1,072	588,38
40712831001000	1200	700	850	0,790	483,75
40716831001000	1600	700	850	1,052	562,50
40719831001000	1900	700	850	1,248	630,00

KAZAN YIKAMA TEZGAHLARI

BOILER WASHING TABLES

KOD Code	EBAT Size (mm)			FİYAT PRICE €
	L	W	H	
99130110001	1200	800	570/910	1.099,13
99130110002	1400	800	570/910	1.216,13



POLİETİLEN TABLALI ÇALIŞMA TEZGAHI TABAN RAFSIZ
PE TOP WORK TABLE WITHOUT BOTTOM SHELF

KOD Code	EBAT Size (mm)			HACİM VOLUME (m ³)	FİYAT PRICE €
	L	W	H		
7061080700000	1000	600	850	0,5668	538,88
7061180700000	1100	600	850	0,6229	571,50
7061280700000	1200	600	850	0,6791	606,38
7061380700000	1300	600	850	0,7352	645,75
7061480700000	1400	600	850	0,7913	680,63
7061580700000	1500	600	850	0,8474	714,38
7061680700000	1600	600	850	0,9035	748,13
7061780700000	1700	600	850	0,9597	789,75
7061880700000	1800	600	850	1,0158	830,25
7061980700000	1900	600	850	1,0719	864,00



Opsiyonel Olarak Demonte
Optional Disassembled

KOD Code	EBAT Size (mm)			HACİM VOLUME (m ³)	FİYAT PRICE €
	L	W	H		
7071080700000	1000	700	850	0,6597	591,75
7071180700000	1100	700	850	0,7250	632,25
7071280700000	1200	700	850	0,7903	675,00
7071380700000	1300	700	850	0,8556	714,38
7071480700000	1400	700	850	0,9210	748,13
7071580700000	1500	700	850	0,9863	789,75
7071680700000	1600	700	850	1,0516	843,75
7071780700000	1700	700	850	1,1169	884,25
7071880700000	1800	700	850	1,1822	925,88
7071980700000	1900	700	850	1,2476	965,25



POLİETİLEN TABLALI ÇALIŞMA TEZGAHI TABAN RAFLI
PE TOP WORK TABLE WITH BOTTOM SHELF

KOD Code	EBAT Size (mm)			HACİM VOLUME (m ³)	FİYAT PRICE €
	L	W	H		
7061080710000	1000	600	850	0,5668	578,25
7061180710000	1100	600	850	0,6229	618,75
7061280710000	1200	600	850	0,6791	659,25
7061380710000	1300	600	850	0,7352	699,75
7061480710000	1400	600	850	0,7913	742,50
7061580710000	1500	600	850	0,8474	789,75
7061680710000	1600	600	850	0,9035	830,25
7061780710000	1700	600	850	0,9597	878,63
7061880710000	1800	600	850	1,0158	925,88
7061980710000	1900	600	850	1,0719	965,25



Opsiyonel Olarak Demonte
Optional Disassembled

KOD Code	EBAT Size (mm)			HACİM VOLUME (m ³)	FİYAT PRICE €
	L	W	H		
7071080710000	1000	700	850	0,6597	626,63
7071180710000	1100	700	850	0,7250	675,00
7071280710000	1200	700	850	0,7903	721,13
7071380710000	1300	700	850	0,8556	776,25
7071480710000	1400	700	850	0,9210	823,50
7071580710000	1500	700	850	0,9863	873,00
7071680710000	1600	700	850	1,0516	925,88
7071780710000	1700	700	850	1,1169	973,13
7071880710000	1800	700	850	1,1822	1.021,50
7071980710000	1900	700	850	1,2476	1.076,63

Çalışma Tezgahları / Work Tables



Opsiyonel Olarak Demonte
Optional Disassembled

MERMER TABLALI ÇALIŞMA TEZGAHI TABAN RAFSIZ
MARBLE TOP WORK TABLE WITHOUT BOTTOM SHELF

KOD Code	EBAT Size (mm)			HACİM VOLUME (m ³)	FİYAT PRICE €
	L	W	H		
70610803000000	1000	600	850	0,5668	637,88
70611803000000	1100	600	850	0,6229	680,63
70612803000000	1200	600	850	0,6791	725,63
70613803000000	1300	600	850	0,7352	769,50
70614803000000	1400	600	850	0,7913	816,75
70615803000000	1500	600	850	0,8474	868,50
70616803000000	1600	600	850	0,9035	915,75
70617803000000	1700	600	850	0,9597	972,00
70618803000000	1800	600	850	1,0158	1.017,00
70619803000000	1900	600	850	1,0719	1.062,00

KOD Code	EBAT Size (mm)			HACİM VOLUME (m ³)	FİYAT PRICE €
	L	W	H		
70710803000000	1000	700	850	0,6597	688,50
70711803000000	1100	700	850	0,7250	742,50
70712803000000	1200	700	850	0,7903	793,13
70713803000000	1300	700	850	0,8556	853,88
70714803000000	1400	700	850	0,9210	904,50
70715803000000	1500	700	850	0,9863	959,63
70716803000000	1600	700	850	1,0516	1.017,00
70717803000000	1700	700	850	1,1169	1.068,75
70718803000000	1800	700	850	1,1822	1.122,75
70719803000000	1900	700	850	1,2476	1.184,63

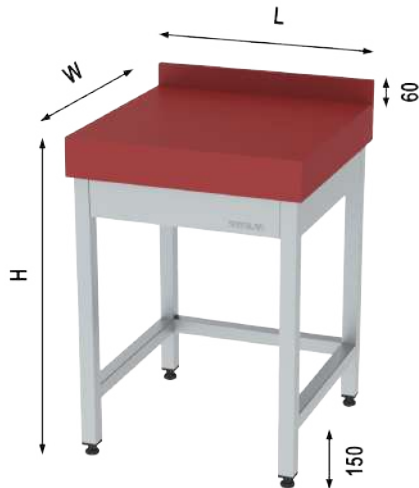

Opsiyonel Olarak Demonte
Optional Disassembled

POLİETİLEN TABLALI ET KÜTÜĞÜ
POLYETHYLENE TOP MEAT CHOPPING TABLE

KOD Code	EBAT Size (mm)			HACİM VOLUME (m ³)	FİYAT PRICE €
	L	W	H		
70606801000000	600	600	850	0,3423	675,00

KOD Code	EBAT Size (mm)			HACİM VOLUME (m ³)	FİYAT PRICE €
	L	W	H		
70707801000000	700	700	850	0,463772	804,00

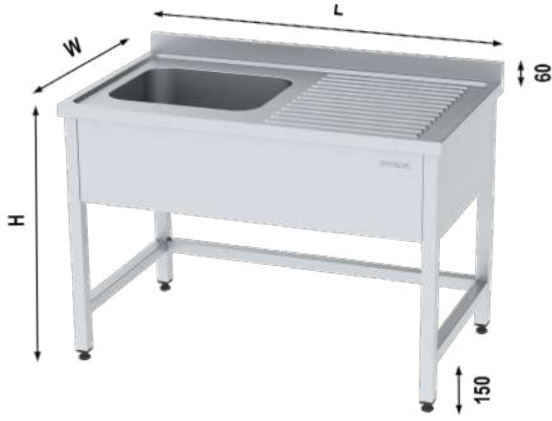

Opsiyonel Olarak Demonte
Optional Disassembled

TEK EVYELİ ÇALIŞMA TEZGAHI ALT TABLASIZ
WORK TABLE WITH SINGLE SINK WITHOUT BOTTOM SHELF

KOD Code	DAMLALIK TİPİ Drip Tray Type	EVYE ADEDİ Sink Quantity	EVYE EBATI Sink Dimens. (cm)	EBAT Size (mm)			HACİM VOLUME (m ³)	FİYAT PRICE €
				L	W	H		
70612808001122	RIGHT-HAND DRIP TRAY / TEK SAĞ DAMLALIKLI	1	40X50X25	1200	600	850	0,679	646,88
70614808001122	RIGHT-HAND DRIP TRAY / TEK SAĞ DAMLALIKLI	1	40X50X25	1400	600	850	0,791	697,50
70616808001122	RIGHT-HAND DRIP TRAY / TEK SAĞ DAMLALIKLI	1	40X50X25	1600	600	850	0,904	731,25
70618808001122	RIGHT-HAND DRIP TRAY / TEK SAĞ DAMLALIKLI	1	40X50X25	1800	600	850	1,016	770,63
70612808002122	LEFT-HAND DRIP TRAY / TEK SOL DAMLALIKLI	1	40X50X25	1200	600	850	0,679	646,88
70614808002122	LEFT-HAND DRIP TRAY / TEK SOL DAMLALIKLI	1	40X50X25	1400	600	850	0,791	697,50
70616808002122	LEFT-HAND DRIP TRAY / TEK SOL DAMLALIKLI	1	40X50X25	1600	600	850	0,904	725,63
70618808002122	LEFT-HAND DRIP TRAY / TEK SOL DAMLALIKLI	1	40X50X25	1800	600	850	1,016	776,25
70712808001123	RIGHT-HAND DRIP TRAY / TEK SAĞ DAMLALIKLI	1	40x50x30	1200	700	850	0,850	720,00
70714808001122	RIGHT-HAND DRIP TRAY / TEK SAĞ DAMLALIKLI	1	40X50X25	1400	700	850	0,921	759,38
70716808001122	RIGHT-HAND DRIP TRAY / TEK SAĞ DAMLALIKLI	1	40X50X25	1600	700	850	1,052	787,50
70718808001123	RIGHT-HAND DRIP TRAY / TEK SAĞ DAMLALIKLI	1	40x50x30	1800	700	850	1,100	911,25
70712808002123	LEFT-HAND DRIP TRAY / TEK SOL DAMLALIKLI	1	40x50x30	1200	700	850	0,850	720,00
70714808002122	LEFT-HAND DRIP TRAY / TEK SOL DAMLALIKLI	1	40X50X25	1400	700	850	0,921	759,38
70716808002122	LEFT-HAND DRIP TRAY / TEK SOL DAMLALIKLI	1	40X50X25	1600	700	850	1,052	781,88
70718808002123	LEFT-HAND DRIP TRAY / TEK SOL DAMLALIKLI	1	40x50x30	1800	700	850	1,100	911,25

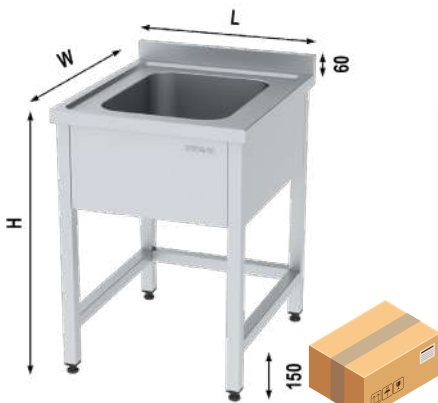

TEK EVYELİ ÇALIŞMA TEZGAHI ALT TABLASIZ
WORK TABLE WITH SINGLE SINK WITHOUT BOTTOM SHELF

KOD Code	EVYE EBATI Sink Dimens. (cm)	EBAT Size (mm)			HACİM VOLUME (m ³)	FİYAT PRICE €
		L	W	H		
70606808000112	40X40X25	600	600	850	0,3423	429,75
70607808000112	40X40X25	700	600	850	0,3984	489,38
70706808000112	40X40X25	600	700	850	0,3984	489,38
70707808000122	40X50X25	700	700	850	0,4637	532,13

Opsiyonel Olarak Demonte
Optional Disassembled

Çalışma Tezgahları / Work Tables



Opsiyonel Olarak Demonte
Optional Disassembled

ÇİFT EVYELİ ÇALIŞMA TEZGAHI ALT TABLASIZ
WORK TABLE WITH DOUBLE SINK WITHOUT BOTTOM

KOD Code	DAMLALIK TİPİ Drip Tray Type	EVYE ADEDİ Sink Quantity	EVYE EBATI Sink Dimens. (cm)	EBAT Size (mm)			HACİM VOLUME (m³)	FİYAT PRICE €
				L	W	H		
70614808001322	RIGHT-HAND DRIP TRAY / SAĞ DAMLALIK	2	40X50X25	1400	600	850	0,791	753,75
70616808001322	RIGHT-HAND DRIP TRAY / SAĞ DAMLALIK	2	40X50X25	1600	600	850	0,904	815,63
70618808001322	RIGHT-HAND DRIP TRAY / SAĞ DAMLALIK	2	40X50X25	1800	600	850	1,016	849,38
70614808002322	LEFT-HAND DRIP TRAY / SOL DAMLALIK	2	40X50X25	1400	600	850	0,791	753,75
70616808002322	LEFT-HAND DRIP TRAY / SOL DAMLALIK	2	40X50X25	1600	600	850	0,904	815,63
70618808002322	LEFT-HAND DRIP TRAY / SOL DAMLALIK	2	40X50X25	1800	600	850	1,016	843,75
70714808001322	RIGHT-HAND DRIP TRAY / SAĞ DAMLALIK	2	40X50X25	1400	700	850	0,921	843,75
70716808001322	RIGHT-HAND DRIP TRAY / SAĞ DAMLALIK	2	40X50X25	1600	700	850	1,052	978,75
70718808001323	RIGHT-HAND DRIP TRAY / SAĞ DAMLALIK	2	40X50X30	1800	700	850	1,182	1.001,25
70714808002322	LEFT-HAND DRIP TRAY / SOL DAMLALIK	2	40X50X25	1400	700	850	0,921	848,25
70716808002322	LEFT-HAND DRIP TRAY / SOL DAMLALIK	2	40X50X25	1600	700	850	1,052	978,75
70718808002323	LEFT-HAND DRIP TRAY / SOL DAMLALIK	2	40X50X30	1800	700	850	1,182	1.001,25
70719808002323	LEFT-HAND DRIP TRAY / SOL DAMLALIK	2	40X50X30	1900	700	850	1,248	1.063,13

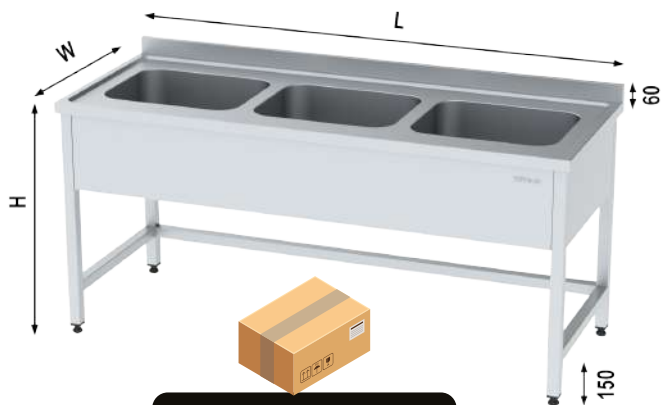

Opsiyonel Olarak Demonte
Optional Disassembled

3 EVYELİ TEZGAH ALT TABLASIZ
SINK WITH 3 BOWLS WITHOUT BOTTOM SHELF

KOD Code	EVYE EBATI Sink Dimens. (cm)	EBAT Size (mm)			HACİM VOLUME (m³)	FİYAT PRICE €
		L	W	H		
70618808000522	40X50X25	1800	600	850	1,016	978,75
70619808000522	40X50X25	1900	600	850	1,072	1.108,13
70718808000523	40X50X30	1800	700	850	1,182	1.175,63
70719808000523	40X50X30	1900	700	850	1,248	1.299,38

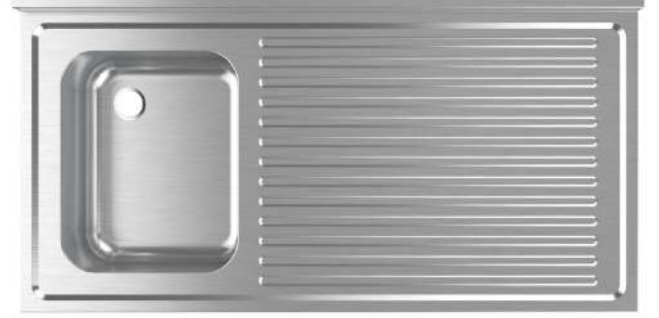
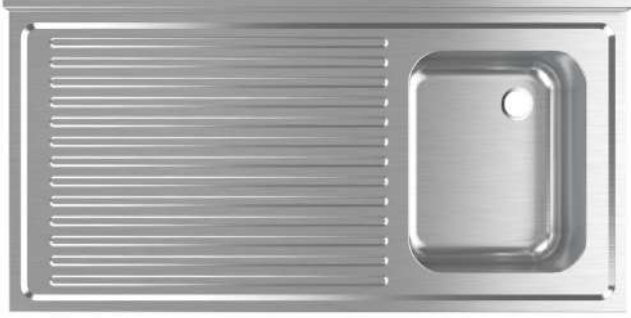

SOL DAMLALIKLI TEK GÖZLÜ EVYE
SINK W. SINGLE BOWL LEFT DRAINER

KOD Code	EVYE EBAT SINK Size (cm)	TABLA EBAT Size (cm)	FİYAT PRICE €
10030310261	40x50x25	120x60	257,63
10030310263	50x50x30	120x70	285,75
10030310265	40x50x25	140x60	285,75
10030310269	50x50x30	140x70	315,00
10030310275	40x50x25	160x60	285,75
10030310279	50x50x30	160x70	334,13
10030310285	50x50x30	190x70	371,25

SAĞ DAMLALIKLI TEK GÖZLÜ EVYE
SINK W. SINGLE BOWL RIGHT DRAINER

KOD Code	EVYE EBAT SINK Size (cm)	TABLA EBAT Size (cm)	FİYAT PRICE €
10030310259	40x50x25	120x60	257,63
10030310262	50x50x30	120x70	285,75
10030310264	40x50x25	140x60	285,75
10030310267	50x50x30	140x70	315,00
10030310274	40x50x25	160x60	285,75
10030310277	50x50x30	160x70	334,13
10030310284	50x50x30	190x70	371,25



SOL DAMLALIKLI ÇİFT GÖZLÜ EVYE
SINK W. DOUBLE BOWL LEFT DRAINER

KOD Code	EVYE EBAT Size (cm)	TABLA EBAT Size (cm)	FİYAT PRICE €
10030310355	40x50x25	140 x 70	455,63
10030310365	40x50x25	160 x 60	455,63
10030310368	40x50x25	160 x 70	478,13
10030310371	40x50x25	180 x 60	478,13
10030310374	50x50x30	180 x 70	562,50
10030310377	40x50x25	190 x 60	489,38
10030310380	50x50x30	190 x 70	573,75

SAĞ DAMLALIKLI ÇİFT GÖZLÜ EVYE
SINK W. DOUBLE BOWL RIGHT DRAINER

KOD Code	EVYE EBAT Size (cm)	TABLA EBAT Size (cm)	FİYAT PRICE €
10030310354	40x50x25	140 x 70	455,63
10030310363	40x50x25	160 x 60	455,63
10030310366	40x50x25	160 x 70	478,13
10030310370	40x50x25	180 x 60	478,13
10030310372	50x50x30	180 x 70	562,50
10030310376	40x50x25	190 x 60	489,38
10030310378	50x50x30	190 x 70	573,75

Sipariş esnasında sağ/sol damlalık özellikleri belirtilmesi gerekmektedir.



BULAŞIK MAKİNESİ GİRİŞ - ÇIKIŞ TEZGAHLI

DISHWASHER MACHINE WITH INLET / OUTLET TABLES

KOD Code	MODEL Type	EBAT TEZGAH Table Size (mm)	EBAT EVYE Sink Size (mm)	FİYAT PRICE €
40110868002122	Giriş Tek Evye Sol	1000 x 750 x 850	400 x 500 x 250	590,63
40114868002122	Giriş Tek Evye Sol	1400 x 750 x 850	400 x 500 x 250	641,25
40116868002122	Giriş Tek Evye Sol	1600 x 750 x 850	400 x 500 x 250	787,50
40110868001122	Giriş Tek Evye Sağ	1000 x 750 x 850	400 x 500 x 250	590,63
40114868001122	Giriş Tek Evye Sağ	1400 x 750 x 850	400 x 500 x 250	641,25
40116868001122	Giriş Tek Evye Sağ	1600 x 750 x 850	400 x 500 x 250	787,50
40114868002322	Giriş Çift Evye Sol	1400 x 750 x 850	400 x 500 x 250	821,25
40116868002322	Giriş Çift Evye Sol	1600 x 750 x 850	400 x 500 x 250	900,00
40118868002322	Giriş Çift Evye Sol	1800 x 750 x 850	400 x 500 x 250	978,75
40114868001322	Giriş Çift Evye Sağ	1400 x 750 x 850	400 x 500 x 250	821,25
40116868001322	Giriş Çift Evye Sağ	1600 x 750 x 850	400 x 500 x 250	900,00
40118868001322	Giriş Çift Evye Sağ	1800 x 750 x 850	400 x 500 x 250	978,75
40108871002000	Çıkış Tezgahı Sol	800 x 750 x 850	400 x 500 x 250	371,25
40110871002000	Çıkış Tezgahı Sol	1000 x 750 x 850	400 x 500 x 250	405,00
40112871002000	Çıkış Tezgahı Sol	1200 x 750 x 850	400 x 500 x 250	450,00
40108871001000	Çıkış Tezgahı Sağ	800 x 750 x 850	400 x 500 x 250	371,25
40110871001000	Çıkış Tezgahı Sağ	1000 x 750 x 850	400 x 500 x 250	405,00
40112871001000	Çıkış Tezgahı Sağ	1200 x 750 x 850	400 x 500 x 250	450,00



EVYELER MAT / SINK SATIN

KOD Code	EBAT / Size (cm)	FİYAT PRICE €
56001000001	40 x 40 x 25	80,00
56001000002	40 x 40 x 30	92,50
56001000003	40 x 50 x 25	100,00
56001000004	40 x 50 x 30	102,50
56001000005	50 x 50 x 25	105,00
56001000006	50 x 50 x 30	110,00
56001000007	50 x 60 x 25	137,50
56001000008	50 x 60 x 30	142,50



DUVAR TİPİ DAVLUMBAZ FİLTRELİ WALL TYPE HOOD WITH FILTER

KOD Code	EBAT Size (mm)	AĞIRLIK Weight (kg)	FİYAT PRICE €
60110101	1000x1000x500	34,00	654,75
60110151	1500x1000x500	44,00	885,38
60112151	1500x1200x500	48,00	956,25
60115151	1500x1500x500	58,00	1.050,75
60110201	2000x1000x500	72,00	1.110,38
60112201	2000x1200x500	97,00	1.198,13
60115201	2000x1500x500	85,00	1.323,00
60115231	2300x1500x500	95,00	1.476,00
60110251	2500x1000x500	105,00	1.328,63
60112251	2500x1200x500	44,00	1.423,13
60115251	2500x1500x500	54,00	1.564,88
60110301	3000x1000x500	64,00	1.546,88
60112301	3000x1200x500	75,00	1.659,38
60115301	3000x1500x500	84,00	1.819,13
60110351	3500x1000x500	95,00	1.896,75
60112351	3500x1200x500	106,00	2.031,75
60115351	3500x1500x500	146,00	2.237,63
60110401	4000x1000x500	49,00	2.108,25
60112401	4000x1200x500	60,00	2.268,00
60115401	4000x1500x500	72,00	2.491,88
60110451	4500x1000x500	83,00	2.350,13
60112451	4500x1200x500	93,00	2.509,88
60115451	4500x1500x500	105,00	2.751,75
60110501	5000x1000x500	117,00	2.551,50
60112501	5000x1200x500	129,00	2.728,13
60115501	5000x1500x500	140,00	2.988,00
60110551	5500x1000x500	154,00	2.787,75
60112551	5500x1200x500	170,00	2.822,63
60115551	5500x1500x500	195,00	2.882,25

Filtre / Filter (50x50): 40 €

Davlumbaz Aydınlatması / Hood Lighting (650x76x160): 130 €

DUVAR TİPİ DAVLUMBAZ FİLTRESİZ WALL TYPE HOOD WITHOUT FILTER

KOD Code	EBAT Size (mm)	AĞIRLIK Weight (kg)	FİYAT PRICE €
60110102	1000x1000x500	34,00	483,75
60106102	1000x600x500	28,00	336,38
60110152	1500x1000x500	44,00	631,13
60112152	1500x1200x500	48,00	702,00
60115152	1500x1500x500	58,00	814,50
60110202	2000x1000x500	72,00	779,63
60112202	2000x1200x500	97,00	861,75
60115202	2000x1500x500	85,00	985,50
60115232	2300x1500x500	95,00	1.092,38
60110252	2500x1000x500	105,00	921,38
60112252	2500x1200x500	44,00	1.021,50
60115252	2500x1500x500	54,00	1.163,25
60110302	3000x1000x500	64,00	1.068,75
60112302	3000x1200x500	75,00	1.168,88
60115302	3000x1500x500	84,00	1.334,25
60110352	3500x1000x500	95,00	1.299,38
60112352	3500x1200x500	106,00	1.434,38
60115352	3500x1500x500	146,00	1.641,38
60110402	4000x1000x500	49,00	1.428,75
60112402	4000x1200x500	60,00	1.599,75
60115402	4000x1500x500	72,00	1.819,13
60110452	4500x1000x500	83,00	1.599,75
60112452	4500x1200x500	93,00	1.753,88
60115452	4500x1500x500	105,00	1.995,75
60110502	5000x1000x500	117,00	1.741,50
60112502	5000x1200x500	129,00	1.913,63
60115502	5000x1500x500	140,00	2.173,50
60110552	5500x1000x500	154,00	1.913,63
60112552	5500x1200x500	170,00	1.948,50
60115552	5500x1500x500	195,00	2.008,13



ORTA TİP DAVLUMBAZ FİLTRELİ MIDDLE TYPE HOOD WITH FILTER

KOD Code	EBAT Size (mm)	AĞIRLIK Weight (kg)	FİYAT PRICE €
60215151	1500x1500x500	68,00	1.203,75
60215201	2000x1500x500	81,00	1.513,13
60220201	2000x2000x500	97,00	1.710,00
60223201	2000x2300x500	72,00	1.816,88
60215251	2500x1500x500	121,00	1.800,00
60220251	2500x2000x500	137,00	2.030,63
60223251	2500x2300x500	153,00	2.154,38
60215301	3000x1500x500	169,00	2.086,88
60220301	3000x2000x500	185,00	2.351,25
60223301	3000x2300x500	201,00	3.403,13
60215351	3500x1500x500	107,00	2.570,63
60220351	3500x2000x500	114,00	2.885,63
60223351	3500x2300x500	120,00	3.082,50
60215401	4000x1500x500	133,00	2.874,38
60220401	4000x2000x500	150,00	3.217,50
60223401	4000x2300x500	167,00	3.431,25
60215451	4500x1500x500	184,00	3.172,50
60220451	4500x2000x500	201,00	3.555,00
60223451	4500x2300x500	218,00	3.780,00
60215501	5000x1500x500	116,00	3.447,00
60220501	5000x2000x500	134,00	3.858,75
60223501	5000x2300x500	149,00	4.100,63
60215551	5500x1500x500	167,00	3.774,38
60220551	5500x2000x500	210,00	4.218,75
60223551	5500x2300x500	250,00	4.488,75
60215581	5800x1500x500	270,00	3.960,00
60220581	5800x2000x500	321,00	4.421,25
60223581	5800x2300x500	370,00	4.696,88

ORTA TİP DAVLUMBAZ FİLTRESİZ MIDDLE TYPE HOOD WITHOUT FILTER

KOD Code	EBAT Size (mm)	AĞIRLIK Weight (kg)	FİYAT PRICE €
60215152	1500x1500x500	68,00	781,88
60215202	2000x1500x500	81,00	956,25
60220202	2000x2000x500	97,00	1.153,13
60223202	2000x2300x500	72,00	1.271,25
60215252	2500x1500x500	121,00	1.119,38
60220252	2500x2000x500	137,00	1.350,00
60223252	2500x2300x500	153,00	1.485,00
60215302	3000x1500x500	169,00	1.276,88
60220302	3000x2000x500	185,00	1.535,63
60223302	3000x2300x500	201,00	1.687,50
60215352	3500x1500x500	107,00	1.580,63
60220352	3500x2000x500	114,00	1.901,25
60223352	3500x2300x500	120,00	2.092,50
60215402	4000x1500x500	133,00	1.749,38
60220402	4000x2000x500	150,00	2.103,75
60223402	4000x2300x500	167,00	2.317,50
60215452	4500x1500x500	184,00	1.923,75
60220452	4500x2000x500	201,00	2.306,25
60223452	4500x2300x500	218,00	2.531,25
60215502	5000x1500x500	116,00	2.092,50
60220502	5000x2000x500	134,00	2.508,75
60223502	5000x2300x500	149,00	2.750,63
60215552	5500x1500x500	167,00	2.266,88
60220552	5500x2000x500	210,00	2.705,63
60223552	5500x2300x500	250,00	2.970,00
60215582	5800x1500x500	270,00	2.368,13
60220582	5800x2000x500	321,00	2.835,00
60223582	5800x2300x500	370,00	3.105,00

Filtre / Filter (50x50): 40 €

Davlumbaz Aydınlatması / Hood Lighting (650x76x160): 130 €



İSTİF RAFI DÜZ
STACKING SHELF

KOD Code	EBAT Size (mm)			HACİM VOLUME (m ³)	FİYAT PRICE €
	L	W	H		
70036150000910	910	360	40	0,017	76,50
70036150000122	1220	360	40	0,023	82,13
70036150000137	1370	360	40	0,026	87,75
70036150000150	1500	360	40	0,028	94,50
70036150000183	1830	360	40	0,034	100,13
70046150000910	910	460	40	0,022	87,75
70046150000122	1220	460	40	0,029	94,50
70046150000137	1370	460	40	0,032	101,59
70046150000150	1500	460	40	0,035	108,00
70046150000183	1830	460	40	0,043	115,76

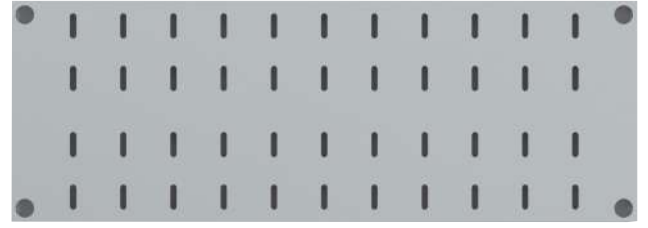

İSTİF RAFI PERFORELİ
STACKING SHELF PERFORATED

KOD Code	EBAT Size (mm)			HACİM VOLUME (m ³)	FİYAT PRICE €
	L	W	H		
70036150100910	910	360	40	0,017	82,13
70036150100122	1220	360	40	0,023	87,75
70036150100137	1370	360	40	0,026	96,75
70036150100150	1500	360	40	0,028	103,50
70036150100183	1830	360	40	0,034	111,38
70046150100910	910	460	40	0,022	96,75
70046150100122	1220	460	40	0,029	103,50
70046150100137	1370	460	40	0,032	111,38
70046150100150	1500	460	40	0,035	120,38
70046150100183	1830	460	40	0,043	127,13



İSTİF RAFLARI 4 KATLI DÜZ
FOUR STOREY STOWAGE SHELF

KOD Code	EBAT Size (mm)			HACİM VOLUME (m ³)	FİYAT PRICE €
	L	W	H		
70036450000910	910	360	1830	0,058	354,38
70036450000122	1220	360	1830	0,077	383,63
70036450000137	1370	360	1830	0,087	410,63
70036450000150	1500	360	1830	0,095	438,75
70036450000183	1830	360	1830	0,116	467,78
70046450000910	910	460	1830	0,074	407,25
70046450000122	1220	460	1830	0,098	430,88
70046450000137	1370	460	1830	0,110	459,00
70046450000150	1500	460	1830	0,121	489,38
70046450000183	1830	460	1830	0,147	519,75

İSTİF RAFLARI 4 KATLI PERFORELİ
FOUR STOREY STOWAGE PERFORATED SHELF

KOD Code	EBAT Size (mm)			HACİM VOLUME (m ³)	FİYAT PRICE €
	L	W	H		
70036450100910	910	360	1830	0,058	389,25
70036450100122	1220	360	1830	0,077	425,25
70036450100137	1370	360	1830	0,087	454,50
70036450100150	1500	360	1830	0,095	482,63
70036450100183	1830	360	1830	0,116	513,00
70046450100910	910	460	1830	0,074	442,13
70046450100122	1220	460	1830	0,098	473,63
70046450100137	1370	460	1830	0,110	507,38
70046450100150	1500	460	1830	0,121	536,63
70046450100183	1830	460	1830	0,147	567,00

Bar Üniteleri

Bar Units



www.kayalarmutfak.com.tr

444 5 957





BAR MODÜLÜ BUZDOLAPLI
BAR MODULE WITH COOLER

Kod / Code	: 207490077010
Boyut / Size (mm)	: 1400 x 700 x 900
Voltaj / Voltage	: 230V 1+N
Güç / Power(Kw)	: 0,26 kW
Paket Ölç./Pkg Dim(mm)	: 1450 x 750 x 1000
Fiyat / Price €	: 3.150,00 €



BAR MODÜLÜ ALT STANDLI
BAR MODULE WITH STAND

Kod / Code	: 7171492110
Boyut / Size (mm)	: 1400 x 700 x 900
Paket Ölç./Pkg Dim(mm)	: 1450 x 750 x 1000
Fiyat / Price €	: 1.293,75 €



MINİ BAR MODÜLÜ ALT STANDLI
MINI BAR MODULE WITH STAND

Kod / Code	: 7170892110
Boyut / Size (mm)	: 800 x 700 x 900
Paket Ölç./Pkg Dim(mm)	: 850 x 750 x 1000
Fiyat / Price €	: 731,25 €

Bar Üniteleri / Bar Units



DOLAPLI ÇALIŞMA TEZGAHI KAHVE ÇEKMECELİ

CUPBOARD WORK TABLE WITH COFFEE DRAWERS

Kod / Code : 70612801700000

Boyut / Size (mm) : 1200 x 600 x 850

Hacim / Volume (m³) : 0,670

Fiyat / Price € : 1.350,00 €



BAR ŞİŞE STANDI

BAR BOTTLE STAND

Kod / Code : 7170598100

Boyut / Size (mm) : 500 x 700 x 900

Paket Ölç./Pkg Dim(mm) : 550 x 750 x 1000

Fiyat / Price € : 618,75 €



BAR PREMİX TEZGAHI (SIRTLI)

BAR PREMIX TABLE (WITH SPLASH BACK)

Kod / Code : 7171497100

Boyut / Size (mm) : 1400 x 700 x 900

Paket Ölç./Pkg Dim(mm) : 1450 x 750 x 1000

Fiyat / Price € : 843,75 €



BAR BARDAK SÜZME MODÜLÜ

BAR CUP STRAINING MODULE

Kod / Code : 7170891100

Boyut / Size (mm) : 800 x 700 x 900

Paket Ölç./Pkg Dim(mm) : 850 x 750 x 1000

Fiyat / Price € : 562,50 €



BAR EVYESİ MODÜLÜ
BAR SINK MODULE

Kod / Code : 7170593100
Boyut / Size (mm) : 500 x 700 x 900
Paket Ölç./Pkg Dim(mm) : 550 x 750 x 1000
Fiyat / Price € : 618,75 €



BAR EVYE - ÇÖP VE BULAŞIK MODÜLÜ
BAR SINK - WASTE AND DISH MODULE

Kod / Code : 7171696100
Boyut / Size (mm) : 1600 x 700 x 900
Paket Ölç./Pkg Dim(mm) : 1650 x 750 x 1000
Fiyat / Price € : 731,25 €



BAR EVYE - ÇÖP MODÜLÜ
BAR SINK AND WASTE MODULE

Kod / Code : 7171095100
Boyut / Size (mm) : 1000 x 700 x 900
Paket Ölç./Pkg Dim(mm) : 1050 x 750 x 1000
Fiyat / Price € : 562,50 €



BAR ÇÖP MODÜLÜ
BAR WASTE MODULE

Kod / Code : 7170594100
Boyut / Size (mm) : 500 x 700 x 900
Paket Ölç./Pkg Dim(mm) : 550 x 750 x 1000
Fiyat / Price € : 225,00 €

ÇÖP KOVALARI FİYATA DAHİL DEĞİLDİR. / TRASH BINS ARE NOT INCLUDED TO THE PRICES

Açık Büfe Üniteleri

Buffet & Service Units

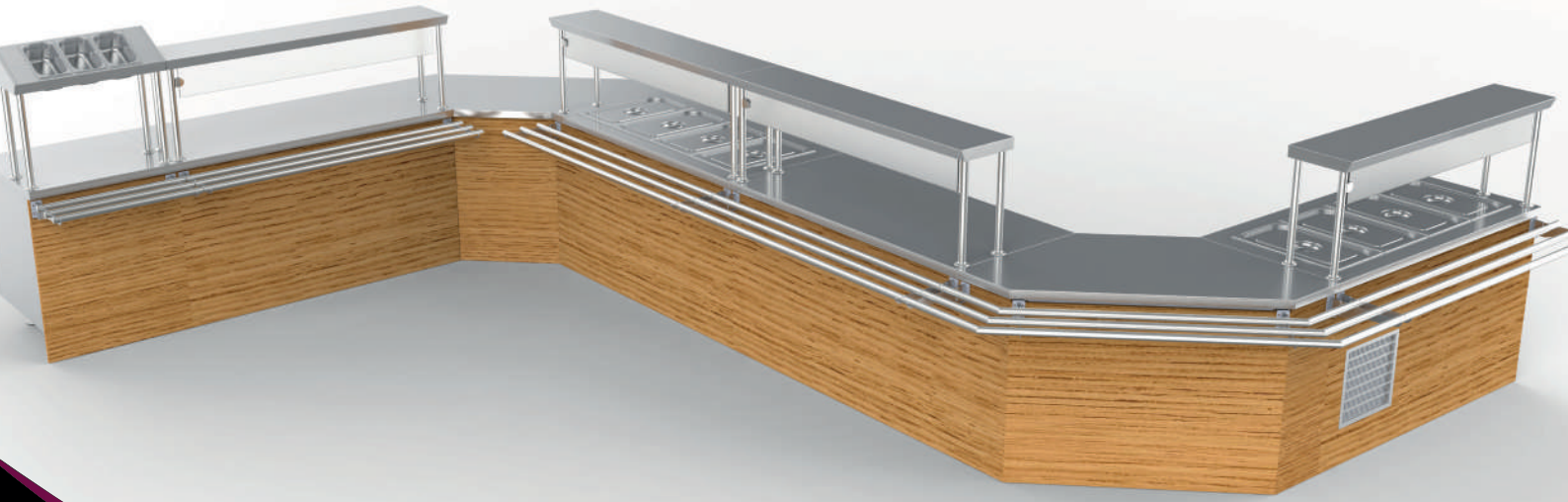

www.kayalarmutfak.com.tr

444 5 957



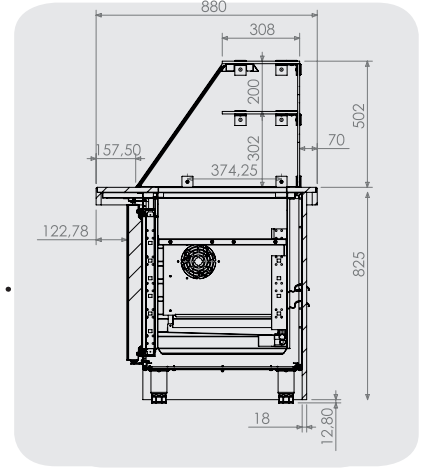

Ölçü Detayları
Dimension Details

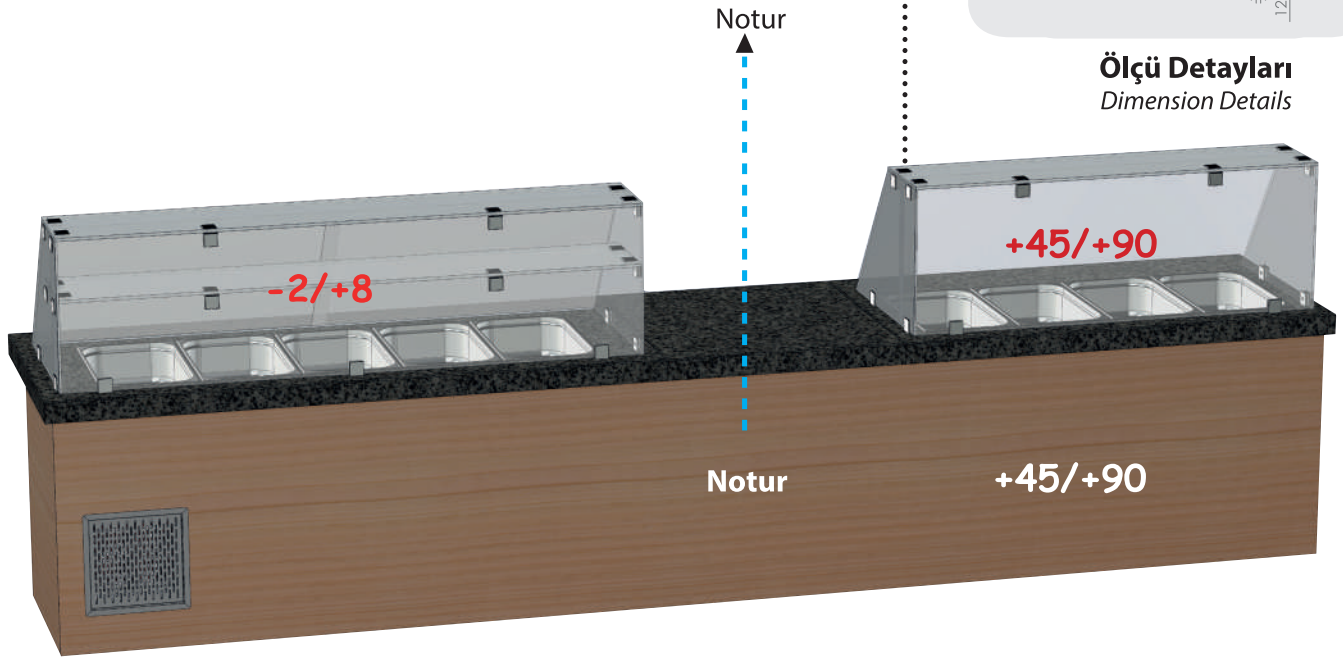

Bilgi

- * İç Gövde Paslanmaz Çelik
- * Dış Gövde Paslanmaz Çelik
- * İç Derinlik: 53 Cm (GN 1/1 Kapasiteli)
- * 35 / 40 Kg/m³ Çevre Dostu HCFC Free
- * Poliüretan İzolasyon
- * Dijital Kumanda Paneli
- * Elektrik Rezistanslı Otomatik Defrost
- * Yüksekliği Ayarlanabilir Paslanmaz Ayaklar
- * Özel Kapı ve Menteşe Sistemi
- * Temizlenebilir ve Sökülebilir Manyetik Kapı Contası
- * CFC Free Soğutma Gazı: R 134 A / R 404 A
- * Dış Ortam Sıcaklığı + 43 °C & % 65 Nem
- * Sıcak Ünitelerde Yukarı Bölüm Ben-Mari

Info

- * Inside Body Stainless Steel
- * Outside Body Stainless Steel
- * Inside Depth: 53 Cm (GN 1/1 Capacity)
- * 35 / 40 Kg/m³ Ecology Friendly HCFC
- * Polyurethane Insulation
- * Digital Control Panel
- * Electrical Resistor Automatic Defrost
- * Stainless Steel Legs Adjustable for Height
- * Special Door and Hinge Systems
- * Removable and Easy Cleaning Magnetic Gasket
- * Cooling Gas CFC Free: R 134 A / R 404 A
- * Ambient Temperature + 43 °C & % 65 Nem
- * In Hot Units the Top is Ben-Marie & Lower

Açık Büfe Üniteleri / Buffet & Service Units



+45/+90

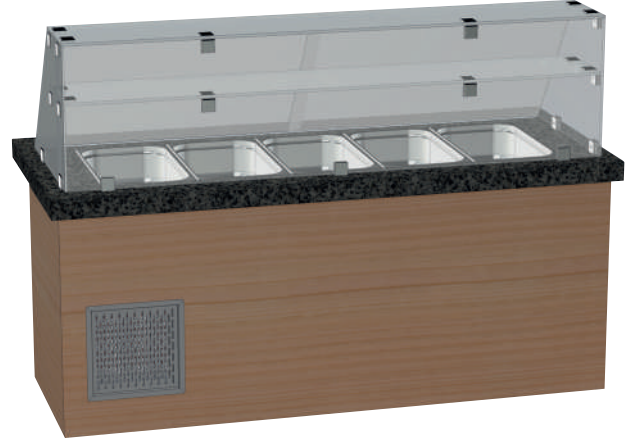

-2/+8

Farklı Ahşap kaplama ve granit seçenekleri için fiyat sorunuz.
Different wood cover and granite options are available. Ask for price

Plexi sürgü kapak
Plexi sliding cover

2 Kapı / Doors
3 Kapı / Doors
4 Kapı / Doors

Kaplama Renk Opsiyonları /
Back Cover Colour Options



Zigana Meşe



Yeni Meşe



Ladin



Kırmızı

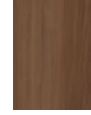

Ceviz



Arusha Wenge

KOD CODE	İÇ SICAKLIK INTERIOR TEMP. °C	HACİM VOLUME (Lt.)	GÜÇ POWER (kW)	EBATLAR DIMENSIONS (mm)	PAKET ÖLÇÜSÜ PACKING DIM. (mm)	AĞIRLIK WEIGHT (Kg)	FİYAT PRICE €
209680011260	-2 / +8	3 Gn 1/1 x 100	0,35	1180 x 880 x 850 / 1350	1300 x 1000 x 1100	170,00	2.981,25
209180011260	-2 / +8	4 Gn 1/1 x 100	0,38	1500 x 880 x 850 / 1350	1600 x 1000 x 1100	180,00	3.487,50
209380111260	-2 / +8	5 Gn 1/1 x 100	0,47	2000 x 880 x 850 / 1350	2100 x 1000 x 1100	220,00	4.387,50
209581111260	-2 / +8	6 Gn 1/1 x 100	0,55	2500 x 880 x 850 / 1350	2600 x 1000 x 1100	250,00	5.400,00
3106901020	Notur	-	-	600 x 880 x 850	720 x 900 x 1100	50,00	956,25
3108901020	Notur	-	-	800 x 880 x 850	920 x 900 x 1100	40,00	1.192,50
3112901222	+40 / +90	3 Gn 1/1 x 100	1,00	1180 x 880 x 850 / 1350	1300 x 1000 x 1100	170,00	2.531,25
3115901222	+40 / +90	4 Gn 1/1 x 100	1,00	1500 x 880 x 850 / 1350	1600 x 1000 x 1100	180,00	3.015,00
3120901222	+40 / +90	5 Gn 1/1 x 100	1,00	2000 x 880 x 850 / 1350	2100 x 1000 x 1100	220,00	3.712,50
3125901222	+40 / +90	6 Gn 1/1 x 100	1,00	2500 x 880 x 850 / 1350	2600 x 1000 x 1100	270,00	4.725,00

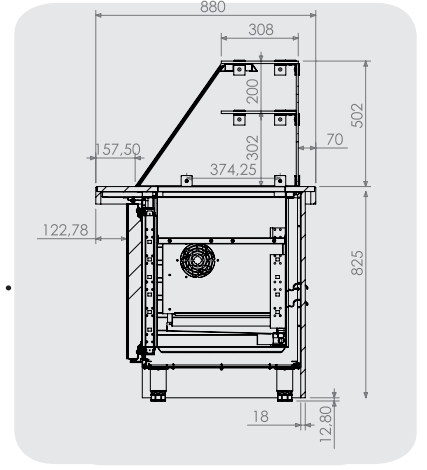

Ölçü Detayları
Dimension Details

Notur

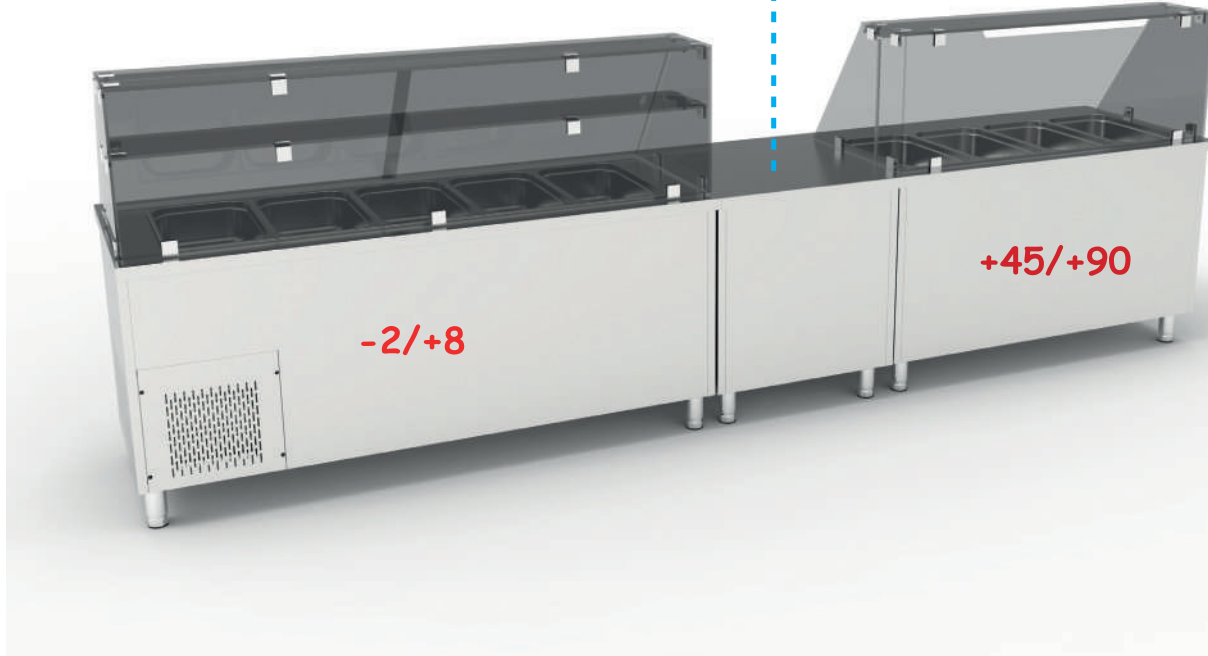

Bilgi

- * İç Gövde Paslanmaz Çelik
- * Dış Gövde Paslanmaz Çelik
- * İç Derinlik: 53 Cm (GN 1/1 Kapasiteli)
- * 35 / 40 Kg/m³ Çevre Dostu HCFC Free
- * Poliüretan İzolasyon
- * Dijital Kumanda Paneli
- * Elektrik Rezistanslı Otomatik Defrost
- * Yüksekliği Ayarlanabilir Paslanmaz Ayaklar
- * Özel Kapı ve Menteşe Sistemi
- * Temizlenebilir ve Sökülebilir Manyetik Kapı Contası
- * CFC Free Soğutma Gazı: R 134 A / R 404 A
- * Dış Ortam Sıcaklığı + 43 °C & % 65 Nem
- * Sıcak Ünitelerde Yukarı Bölüm Ben-Mari
- * Müşteri tarafında 2 cm Ahşap Kaplama
- * Buzlu cam - Cam İçinde LED Işık
- * Işıklı Cam Bölüm
- * 88 Cm 2 Cm Granit Üst Tabla

Info

- * Inside Body Stainless Steel
- * Outside Body Stainless Steel
- * Inside Depth: 53 Cm (GN 1/1 Capacity)
- * 35 / 40 Kg/m³ Ecology Friendly HCFC
- * Polyurethane Insulation
- * Digital Control Panel
- * Electrical Resistor Automatic Defrost
- * Stainless Steel Legs Adjustable for Height
- * Special Door and Hinge Systems
- * Removable and Easy Cleaning Magnetic Gasket
- * Cooling Gas CFC Free: R 134 A / R 404 A
- * Ambient Temperature + 43 °C & % 65 Nem
- * In Hot Units the Top is Ben-Marie & Lower
- * At the front 2 cm Wood Cover
- * Iced Glass with Inside LED Lighting
- * Glass Cover with LED Light
- * 88 Cm 2 Cm Granite Top

Açık Büfe Üniteleri / Buffet & Service Units



+45/+90



-2/+8

Plexi sürgü kapak
Plexi sliding cover

2 Kapı / Doors

3 Kapı / Doors

4 Kapı / Doors



Nötr

KOD CODE	İÇ SICAKLIK INTERIOR TEMP. °C	HACİM VOLUME (Lt.)	GÜÇ POWER (kW)	EBATLAR DIMENSIONS (mm)	PAKET ÖLÇÜSÜ PACKING DIM. (mm)	AĞIRLIK WEIGHT (kg)	FİYAT PRICE €
209680011280	-2 / +8	3 Gn 1/1 x 100	0,35	1105 x 800 x 850 /1350	1300 x 1000 x 1100	170,00	2.587,50
209180011280	-2 / +8	4 Gn 1/1 x 100	0,38	1430 x 800 x 850 /1350	1600 x 1000 x 1100	18,00	2.919,38
209380111280	-2 / +8	5 Gn 1/1 x 100	0,47	1910 x 800 x 850 /1350	2100 x 1000 x 1100	220,00	3.161,25
209581111280	-2 / +8	6 Gn 1/1 x 100	0,55	2400 x 800 x 850 /1350	2600 x 1000 x 1100	250,00	3.937,50
3105900000	Notur	-	-	520 x 800 x 850	720 x 900 x 1100	50,00	843,75
3107900000	Notur	-	-	720 x 800 x 850	920 x 900 x 1100	70,00	990,00
3111900202	+40 / +90	3 Gn 1/1 x 100	1,00	1105 x 800 x 850 /1350	1300 x 1000 x 1100	170,00	2.025,00
3114900202	+40 / +90	4 Gn 1/1 x 100	1,00	1430 x 800 x 850 /1350	1600 x 1000 x 1100	180,00	2.193,75
3119900202	+40 / +90	5 Gn 1/1 x 100	1,00	1910 x 800 x 850 /1350	2100 x 1000 x 1100	220,00	3.037,50
3124900202	+40 / +90	6 Gn 1/1 x 100	1,00	2400 x 800 x 850 /1350	2600 x 1000 x 1100	270,00	3.262,50

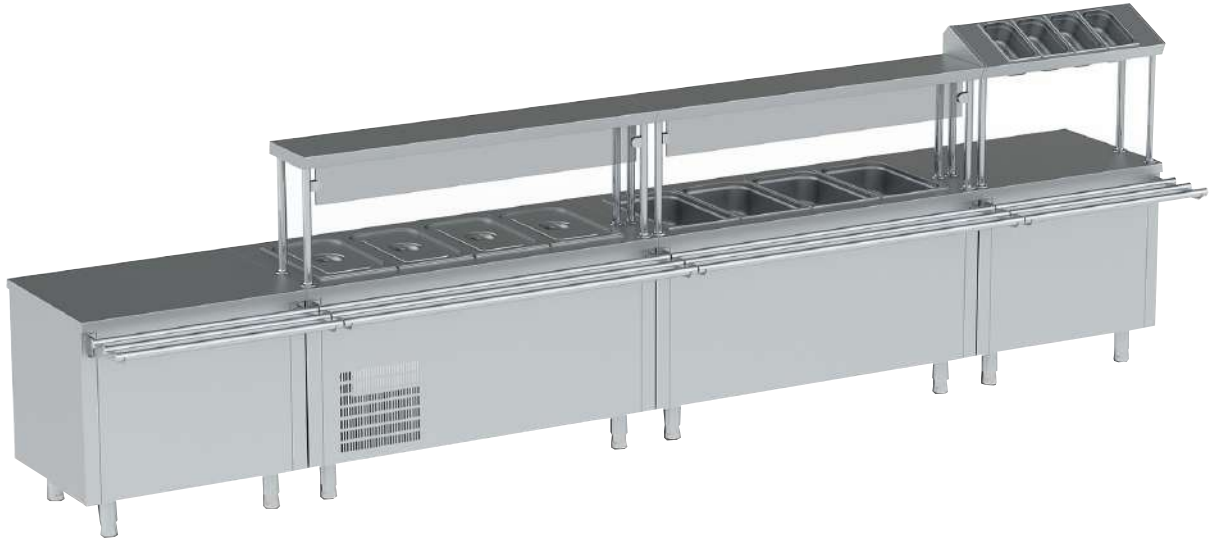

SERVİS HATTI

SERVICE LINE



- Elektrikli
- GN 1/1 4, 5 ve 6 Hazneli
- Termostatik kontrollüdür.
- Boşaltma vanalı

- Electrical
- With GN 1/1 4, 5 ve 6 reservoir
- Thermostat controlled
- With drain valve

SICAK SERVİS ÜNİTESİ HOT SERVICE UNIT

KOD Code	Tipi Type	EBAT Size (mm)	AĞIRLIK Weight (kg)	FİYAT PRICE €
3012000202	ELEKTRİKLİ	1200 x 700 x 850 3 x Gn 1/1 150	85,00	1.350,00
3015000202	ELEKTRİKLİ	1500 x 700 x 850 4 x Gn 1/1 150	99,00	1.462,50
3018000202	ELEKTRİKLİ	1800 x 700 x 850 5 x Gn 1/1 150	118,00	1.856,25
3021000202	ELEKTRİKLİ	2100 x 700 x 850 6 x Gn 1/1 150	133,00	2.250,00

KÜVET, KAYDIRMA STANDI VE SERVİS RAFI FİYATLARA DAHİL DEĞİLDİR.
GN CONTAINER, SLIDING STAND & SHELF PRICES ARE NOT INCLUDED.

Açık Büfe Üniteleri / Buffet & Service Units



- Elektrikli
- GN 1/1 4, 5 ve 6 Hazneli
- Termostatik kontrollüdür.
- Boşaltma vanalı
- Electrical
- With GN 1/1 4, 5 ve 6 reservoir
- Thermostat controlled
- With drain valve

SOĞUK SERVİS ÜNİTESİ COLD SERVICE UNIT

KOD Code	EBAT Size (mm)	AĞIRLIK Weight (kg)	FİYAT PRICE €
3012000302	1200 x 700 x 850 3 x Gn 1/1 100	85,00	1.687,50
3015000302	1500 x 700 x 850 4 x Gn 1/1 100	99,00	1.856,25
3018000302	1800 x 700 x 850 5 x Gn 1/1 100	118,00	2.3,50
3021000302	2100 x 700 x 850 6 x Gn 1/1 100	133,00	2.812,50



NÖTR SERVİS ÜNİTESİ NEUTRAL SERVICE UNIT

KOD Code	EBAT Size (mm)	AĞIRLIK Weight (kg)	FİYAT PRICE €
3007000000	700 x 700 x 850	60,00	675,00
3009000000	900 x 700 x 850	75,00	731,25
3012000000	1200 x 700 x 850	102,00	900,00
3015000000	1500 x 700 x 850	121,00	1.125,00

KÜVET, KAYDIRMA STANDI VE SERVİS RAFI FİYATLARA DAHİL DEĞİLDİR.
GN CONTAINER, SLIDING STAND & SHELF PRICES ARE NOT INCLUDED.



KULE TİP DOLAP
TOWER TYPE CUPBOARD

KOD Code	GÜÇ POWER (W)	VOLTAJ VOLTAGE	EBAT Size (mm)	FİYAT PRICE €
99050390007	0,55	230V 50-60Hz	1500 x 700 x 1600	7.300,00
99050390039	0,55	230V 50-60Hz	1900 x 700 x 1600	9.250,00



KÖŞE TEZGAHI (İÇ & DIŞ KÖŞE)
CORNER WORKING TABLE (INNER & OUTER CORNER)

KOD Code	EBAT Size (mm)	AĞIRLIK Weight (kg)	FİYAT PRICE €
3098000000	90° Dış Köşe	85,00	1.068,75
3099000000	90° İç Köşe	85,00	1.068,75

KÜVET, KAYDIRMA STANDI VE SERVİS RAFI FİYATLARA DAHİL DEĞİLDİR.
GN CONTAINER, SLIDING STAND & SHELF PRICES ARE NOT INCLUDED.

Açık Büfe Üniteleri / Buffet & Service Units



KASA TEZGAHI
CASH DESK

KOD Code	AÇIKLAMA DESCRIPTION	EBAT Size (mm)	AĞIRLIK Weight (kg)	PRICE €
3012000500	SAĞ GİRİŞ	1200 x 700 x 850	90,00	1.125,00
3012000600	SOL GİRİŞ	1200 x 700 x 850	90,00	1.125,00

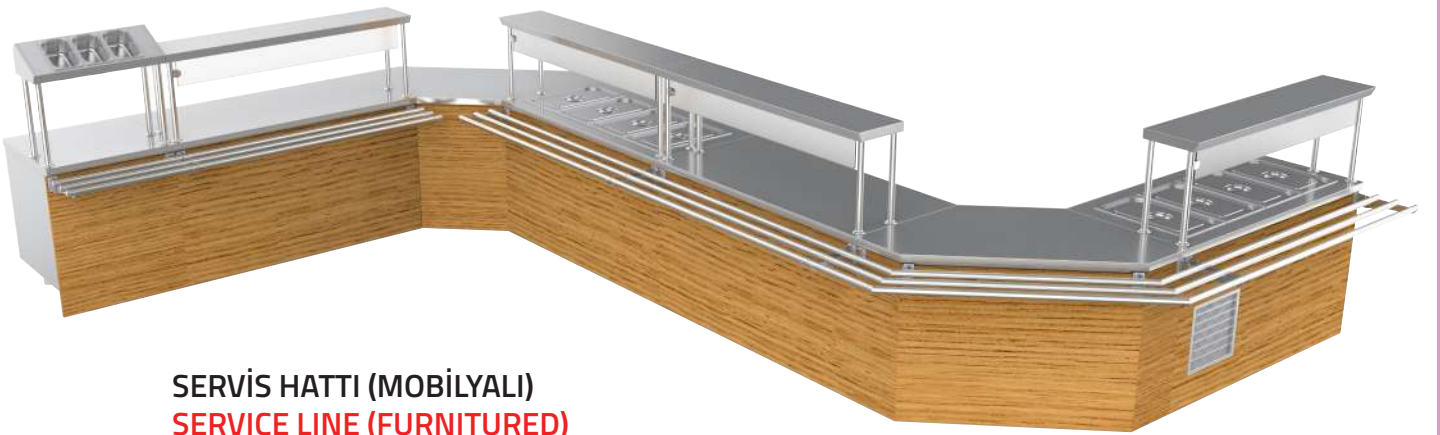

SERVİS HATTI (MOBİLYALI)
SERVICE LINE (FURNITURED)



- Elektrikli
- GN 1/1 4, 5 ve 6 Hazneli
- Termostatik kontrollüdür.
- Boşaltma vanalı

- Electrical
- With GN 1/1 4, 5 ve 6 reservoir
- Thermostat controlled
- With drain valve

SICAK SERVİS ÜNİTESİ (MOBİLYALI) HOT SERVICE UNIT (FURNITURED)

KOD Code	Tipi Type	EBAT Size (mm)	AĞIRLIK Weight (kg)	FİYAT PRICE €
3012001202	ELEKTRİKLİ	1200 x 700 x 850 3 x Gn 1/1 150	85,00	1.631,25
3015001202	ELEKTRİKLİ	1500 x 700 x 850 4 x Gn 1/1 150	99,00	1.721,25
3018001202	ELEKTRİKLİ	1800 x 700 x 850 5 x Gn 1/1 150	118,00	2.025,00
3021001202	ELEKTRİKLİ	2100 x 700 x 850 6 x Gn 1/1 150	133,00	2.531,25



- Elektrikli
- GN 1/1 4, 5 ve 6 Hazneli
- Termostatik kontrollüdür.
- Boşaltma vanalı

- Electrical
- With GN 1/1 4, 5 ve 6 reservoir
- Thermostat controlled
- With drain valve

SOĞUK SERVİS ÜNİTESİ (MOBİLYALI) COLD SERVICE UNIT (FURNITURED)

KOD Code	MODEL	EBAT Size (mm)	AĞIRLIK Weight (kg)	FİYAT PRICE €
3012001302	ELEKTRİKLİ	1200 x 700 x 850 3 x Gn 1/1 100	85,00	1.890,00
3015001302	ELEKTRİKLİ	1500 x 700 x 850 4 x Gn 1/1 100	99,00	2.070,00
3018001302	ELEKTRİKLİ	1800 x 700 x 850 5 x Gn 1/1 100	118,00	2.475,00
3021001302	ELEKTRİKLİ	2100 x 700 x 850 6 x Gn 1/1 100	133,00	2.925,00

KÜVET, KAYDIRMA STANDI VE SERVİS RAFI FİYATLARA DAHİL DEĞİLDİR.
GN CONTAINER, SLIDING STAND & SHELF PRICES ARE NOT INCLUDED.

Açık Büfe Üniteleri / Buffet & Service Units



NÖTR SERVİS ÜNİTESİ (MOBİLYALI)
NEUTRAL SERVICE UNIT (FURNITURED)

KOD Code	EBAT Size (mm)	AĞIRLIK Weight (kg)	FİYAT PRICE €
3007001000	700 x 700 x 850	60,00	877,50
3009001000	900 x 700 x 850	75,00	956,25
3012001000	1200 x 700 x 850	102,00	1.181,25
3015001000	1500 x 700 x 850	121,00	1.406,25



KULE TİP DOLAP (MOBİLYALI)
TOWER TYPE CUPBOARD

KOD Code	GÜÇ Power (kW)	VOLTAJ	EBAT Size (mm)	FİYAT PRICE €
99050390008	0,55	230V 50-60Hz	1500 x 700 x 1600	9.080,00
99050390009	0,55	230V 50-60Hz	1900 x 700 x 1600	11.000,00



KÖŞE TEZGAHI (İÇ& DIŞ KÖŞE) MOBİLYALI
CORNER WORKING TABLE (INNER & OUTER) FURNITURED

KOD Code	EBAT Size (mm)	AĞIRLIK Weight (kg)	FİYAT PRICE €
3098001000	90° Dış Köşe	110,00	1.237,50
3099001000	90° İç Köşe	110,00	1.237,50



KASA TEZGAHI
CASH DESK

KOD Code	AÇIKLAMA DESCRIPTION	EBAT Size (mm)	AĞIRLIK Weight (kg)	FİYAT PRICE €
3012001500	SAĞ GİRİŞ	1200 x 700 x 850	125,00	1.293,75
3012001600	SOL GİRİŞ	1200 x 700 x 850	125,00	1.293,75

Açık Büfe Üniteleri / Buffet & Service Units



- Ekmek, çatal, bıçak, kaşık servisi için üretilmiştir.
- Isıtmasız, soğutmasız nötr bir ünedir.
- Made for distribute bread and forks, knives, spoons service
- It's a neutral unit.

KÜVER ÜNİTESİ MODÜLÜ SERVICE UNIT MODULE

KOD Code	EBAT Size (mm)	AĞIRLIK Weight (kg)	FİYAT PRICE €
3107150000	700 (3 x Gn 1/4 150)	70,00	202,50
3109150000	900 (4 x Gn 1/4 150)	90,00	247,50

KÜVET, KAYDIRMA STANDI VE SERVİS RAFI FİYATLARA DAHİL DEĞİLDİR.
GN CONTAINER, SLIDING STAND & SHELF PRICES ARE NOT INCLUDED.



BARDAK ÜNİTESİ MODÜLÜ SERVICE UNIT MODULE

KOD Code	EBAT Size (mm)	AĞIRLIK Weight (kg)	FİYAT PRICE €
3107160000	700 x 540 x 700	45,00	787,50



SERVİS RAFI (Lüks)

SERVICE SHELF (Lux)

KOD Code	EBAT Size (mm)	FİYAT PRICE €
3112140002	1200 x 300 x 500	360,00
3114140002	1400 x 300 x 500	405,00
3115140002	1500 x 300 x 500	450,00
3118140002	1800 x 300 x 500	506,25
3121140002	2100 x 300 x 500	562,50



SERVİS RAFI

SERVICE SHELF

KOD Code	EBAT Size (mm)	FİYAT PRICE €
3107120000	700 x 300 x 500	180,00
3109120000	900 x 300 x 500	225,00
3112120000	1200 x 300 x 500	258,75
3115120000	1500 x 300 x 500	298,13
3118120000	1800 x 300 x 500	331,88
3121120000	2100 x 300 x 500	371,25
3107130000	700 x 300 x 400 / 300	258,75
3109130000	900 x 300 x 400 / 300	298,13
3112130000	1200 x 300 x 400 / 300	331,88
3115130000	1500 x 300 x 400 / 300	371,25
3118130000	1800 x 300 x 400 / 300	405,00
3121130000	2100 x 300 x 400 / 300	444,38



KAYDIRMA STANDI

TRAY SLIDER

KOD Code	EBAT Size (mm)	FİYAT PRICE €
3107100000	700 x 300 x 100	123,75
3109100000	900 x 300 x 100	135,00
3112100000	1200 x 300 x 100	151,88
3115100000	1500 x 300 x 100	174,38
3118100000	1800 x 300 x 100	196,88
3121100000	2100 x 300 x 100	253,13

Açık Büfe Üniteleri / Buffet & Service Units

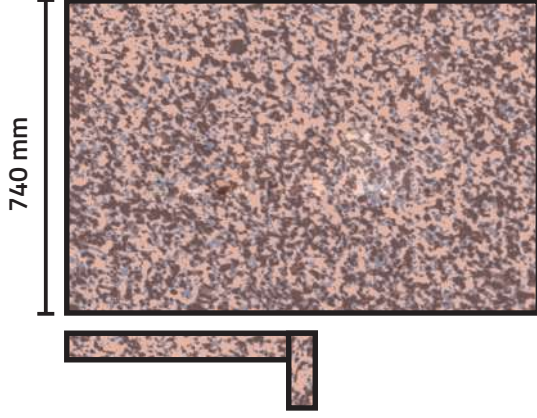

SELF SERVİS GRANİT TABLA
(Nötr Ürünler için)

SELF SERVICE GRANITE TABLE FOR NEUTRAL PRODUCT

EBAT Size (mm)	FİYAT PRICE €
900 x 700 x 20	Fiyat Sorunuz
1150 x 700 x 20	Fiyat Sorunuz
1470 x 700 x 20	Fiyat Sorunuz
1500 x 700 x 20	Fiyat Sorunuz
1800 x 700 x 20	Fiyat Sorunuz
1900 x 700 x 20	Fiyat Sorunuz
2100 x 700 x 20	Fiyat Sorunuz



SELF SERVİS GRANİT TABLA
(Nötr Ürünler için)

SELF SERVICE GRANITE TABLE FOR NEUTRAL PRODUCT

EBAT Size (mm)	FİYAT PRICE €
900 x 700 x 20	Fiyat Sorunuz
1150 x 700 x 20	Fiyat Sorunuz
1470 x 700 x 20	Fiyat Sorunuz
1500 x 700 x 20	Fiyat Sorunuz
1800 x 700 x 20	Fiyat Sorunuz
1900 x 700 x 20	Fiyat Sorunuz
2100 x 700 x 20	Fiyat Sorunuz

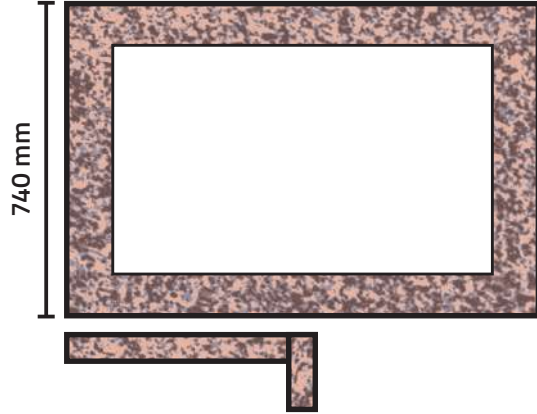

SELF SERVİS GRANİT TABLA
(Hazneli Ürünler için)

SELF SERVICE GRANITE TABLE FOR NEUTRAL PRODUCT

EBAT Size (mm)	FİYAT PRICE €
1150 x 700 x 20	Fiyat Sorunuz
1470 x 700 x 20	Fiyat Sorunuz
1800 x 700 x 20	Fiyat Sorunuz
2100 x 700 x 20	Fiyat Sorunuz



SELF SERVİS GRANİT TABLA
(Hazneli Ürünler için)

SELF SERVICE GRANITE TABLE FOR NEUTRAL PRODUCT

EBAT Size (mm)	FİYAT PRICE €
1150 x 700 x 20	Fiyat Sorunuz
1470 x 700 x 20	Fiyat Sorunuz
1800 x 700 x 20	Fiyat Sorunuz
2100 x 700 x 20	Fiyat Sorunuz

HAMBURGER HAZIRLIK TEZGAHI BURGER PREPARATION LINE

Boyut / Size : 2800 x 1400 x 1900

Kod / Code : 802281302

Fiyat / Price : 2.475,00 €



HAMBURGER HAZIRLIK TEZGAHI BURGER PREPARATION LINE

Boyut / Size : 2900 x 1200 x 850 x 1850

Kod / Code : 802281402

Fiyat / Price : 5.625,00 €



Açık Büfe Üniteleri / Buffet & Service Units



SICAK TUTUCU HEAT HOLDING CABINETS

Boyut / Size : 920 x 470 x 575

Kod / Code : 802951102

Fiyat / Price : 675,00 €



PATATES DİNLENDİRME CHIPS SCUTTLE

Boyut / Size : 1000 x 850 x 850 x 1700

Kod / Code : 802180402

Fiyat / Price : 1.800,00 €



HATCO SICAK TUTUCU HATCO LAMP UNIT

800mm

KOD / Code : 802801102

Fiyat / Price : 506,25 €

1250mm

KOD / Code : 802121102

Fiyat / Price : 787,50 €



PİZZA HAZIRLIK DOLABI PIZZA PREPARITION REFRIGERATOR

Kapı / Door : 4
Boyut / Size : 2372 x 700 x 850 / 1350
Kod / Code : 207281111910
Fiyat / Price : 7.425,00 €

Kapı / Door : 3
Boyut / Size : 1886 x 700 x 850 / 1350
Kod / Code : 207881111910
Fiyat / Price : 6.525,00 €



PİZZA HAZIRLIK TEZGAHI PIZZA PREPARITION WORK TABLE

Boyut / Size : 1300 x 1300 x 2000
Kod / Code : 802121702
Fiyat / Price : 1.125,00 €

Açık Büfe Üniteleri / Buffet & Service Units

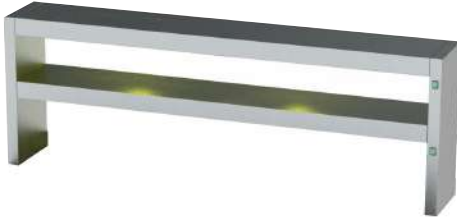

SALAMANDER

Boyut / Size : 1900 x 300

KOD / Code : 802192002

Fiyat / Price : 1.575,00 €

Boyut / Size : 1400 x 300

KOD / Code : 802142002

Fiyat / Price : 1.125,00 €



PIZZA KUTU ISITMA RAFI PIZZA HEATING SHELF

Boyut / Size : 1650 x 500 x 1600

Kod / Code : 802111802

Fiyat / Price : 1.000,00 €



BARDAK OTOMATI CUP DISPENSER

Boyut / Size : Ø135 x 600

Kod / Code : 10020110101

Fiyat / Price : 168,75 €

BANKET ARABASI

BANQUET TROLLEY

KOD Code	ÇALIŞMA ARALIĞI	KAPASİTE Capacity (Lt.)	GÜÇ Power (kw)	VOLTAJ Voltage	EBAT Size (mm)	FİYAT PRICE €
320800002	+30°C, +90°C	2/1 100 x 10	1,70	230V 1+N - 50/60Hz	820 x 920 x 1745	2.250,00
320800004	+30°C, +90°C	2/1 100 x 20	2,55	230V 1+N - 50/60Hz	1520 x 920 x 1745	3.500,00



- * Poliüretan gövde
- * Termostat kontrol
- * İç ısı göstergesi
- * Kilitlenebilir tekerlek
- * Polyurethane body
- * Thermostat control
- * Internal temperature display
- * Lockable wheel



TEŞHİR DOLABI DÜZ SOĞUK
COLD CAKE DISPLAY UNIT FLAT

KOD Code	MODEL	GÜÇ Power (kW)	İÇ SICAKLIK Temperatura	VOLTAJ Voltage	EBAT Size (mm)	AĞIRLIK Weight (kg)	FİYAT PRICE €
3200112001	ÇARPMA KAPILI - HINGED DOORS	0,35	+2 / +10	220 V	800x700x1350	90,00	3.150,00
3200112002	ÇARPMA KAPILI - HINGED DOORS	0,50	+2 / +10	220 V	1000x700x1350	110,00	3.510,00
3200112012	KAYAR KAPILI - SLIDING DOORS	0,50	+2 / +10	220 V	1000x700x1350	110,00	3.600,00
3200112013	KAYAR KAPILI - SLIDING DOORS	0,50	+2 / +10	220 V	1500x700x1350	160,00	4.680,00
3200112014	KAYAR KAPILI - SLIDING DOORS	0,50	+2 / +10	220 V	1800x700x1350	200,00	5.220,00



TEŞHİR DOLABI DÜZ SICAK
HOT CAKE DISPLAY UNIT FLAT

KOD Code	MODEL	GÜÇ Power (kW)	İÇ SICAKLIK Temperatura	VOLTAJ Voltage	EBAT Size (mm)	AĞIRLIK Weight (kg)	FİYAT PRICE €
3200102001	ÇARPMA KAPILI - HINGED DOORS	0,35	+30 / +60	220 V	800x700x1350	90,00	2.250,00
3200102002	ÇARPMA KAPILI - HINGED DOORS	0,50	+30 / +60	220 V	1000x700x1350	110,00	2.790,00
3200102012	KAYAR KAPILI - SLIDING DOORS	0,50	+30 / +60	220 V	1000x700x1350	110,00	2.880,00
3200102013	KAYAR KAPILI - SLIDING DOORS	0,50	+30 / +60	220 V	1500x700x1350	160,00	3.600,00

Yardımcı Ekipmanlar

Kitchen Auxiliary Equipments



www.kayalarmutfak.com.tr

444 5 957





HELVANE TENCERE KAPAKLI / WIDE POT WITH LID

KOD Code	ÇAP Diameter (cm)	YÜKSEKLİK Height (cm)	KAPASİTE Capacity (Lt.)	FİYAT PRICE €
51011000003	30	15	9,50	75,00
51011000004	36	15	14,00	80,00
51011000005	36	20	18,00	85,00
51011000006	40	17	19,00	91,25
51011000007	45	20	28,00	112,50
51011000008	50	20	35,00	131,25
51011000009	55	20	43,0	150,00
51011000010	60	20	50,00	176,25
51011000011	65	25	75,00	250,00
51011000012	70	20	69,00	307,50
51011000013	70	30	104,00	360,00
51011000014	80	20	90,00	475,00
51011000015	80	30	136,00	500,00
51011000016	90	30	171,00	562,50
51011000001	100	30	211,00	787,50
51011000002	110	35	290,00	875,00
51011000017	110	60	550,00	2.500,00



KIZARTMA TAVASI ÇİFT SAPLI KAPAKSIZ / FRYING PAN D.H.

KOD Code	ÇAP Diameter (cm)	YÜKSEKLİK Height (cm)	KAPASİTE Capacity (Lt.)	FİYAT PRICE €
52006000001	36	9	9,00	90,00
52006000006	40	11	14,00	105,00
52006000007	45	12	19,00	125,00
52006000014	50	12	25,00	148,75
52006000008	55	14	31,00	180,00
52006000009	60	14	39,00	240,00
52006000010	65	14	46,00	275,00
52006000011	70	15	57,00	316,25
52006000012	80	16	80,00	440,00
52006000013	90	20	101,00	491,25
52006000003	100	18	141,00	591,25
52006000004	110	20	189,00	793,75



ÇELİK SÜZGEÇ KAPAKSIZ / STRAINER

KOD Code	ÇAP Diameter (cm)	YÜKSEKLİK Height (cm)	KAPASİTE Capacity (Lt.)	FİYAT PRICE €
51006000001	36	8	9,00	56,25
51006000002	40	10	14,00	61,88
51006000003	45	11	19,00	67,50
51006000004	50	11	25,00	84,38
51006000005	55	13	31,00	90,00
51006000006	60	13	39,00	94,50
51006000007	65	13	46,00	112,50
51006000008	70	14	57,00	141,75
51006000009	80	15	80,00	191,25
51006000010	90	18	101,00	258,75
51006000011	100	18	141,00	337,50
51006000012	110	18	162,00	405,00

SİLİNDİRİK DERİN TENCERE KAPAKLI CYLINDRICAL STEW POT DEEP WITH LID



KOD Code (Mat - Satin)	ÇAP Diameter (cm)	YÜKSEKLİK Height (cm)	KAPASİTE Capacity (Lt.)	FİYAT PRICE €
51016000002	16	16	3,1	37,50
51016000004	18	18	4,4	40,00
51016000007	20	20	6,1	50,00
51016000011	24	20	8,8	63,75
51016000012	24	24	11	70,00
51016000015	28	28	17	95,00
51016000034	30	30	21	97,50
51016000018	32	32	25	140,00
51016000020	35	35	33	155,00
51016000023	40	40	49	187,50
51016000026	45	45	69	275,00
51016000029	50	50	95	387,50

SİLİNDİRİK ORTA TENCERE KAPAKLI CYLINDRICAL STEW POT MIDDLE WITH LID



KOD Code (Mat - Satin)	ÇAP Diameter (cm)	YÜKSEKLİK Height (cm)	KAPASİTE Capacity (Lt.)	FİYAT PRICE €
51016000001	16	11	2,10	37,50
51016000035	18	12	3,00	40,00
51016000006	20	13	4,00	43,75
51016000010	24	15	6,60	62,50
51016000014	28	17	10,00	75,00
51016000033	30	20	13,90	81,25
51016000017	32	20	16,00	100,00
51016000019	35	22	21,00	137,50
51016000022	40	25	30,00	168,75
51016000025	45	28	43,00	225,00
51016000028	50	30	57,00	293,75
51016000031	65	35	110,00	456,25

SİLİNDİRİK SIĞ TENCERE KAPAKLI CYLINDRICAL STEW POT SHALLOW WITH LID



KOD Code (Mat - Satin)	ÇAP Diameter (cm)	YÜKSEKLİK Height (cm)	KAPASİTE Capacity (Lt.)	FİYAT PRICE €
51016000003	16	8	1,60	35,00
51016000005	18	9	2,20	40,00
51016000008	20	9	2,70	42,50
51016000009	24	10	4,40	60,00
51016000013	28	12	7,20	70,00
51016000036	30	15	10,40	75,00
51016000016	32	15	12,00	86,25
51016000032	35	17	16,00	118,75
51016000021	40	20	24,00	150,00
51016000024	45	22	34,00	200,00
51016000027	50	20	38,00	287,50
51016000030	65	25	80,00	425,00

KAPAKLI KARNİYARİK TENCERE / BRAZIER WITH LID



KOD CODE (MAT/SATIN)	ÇAP DIAMETER (cm)	YÜKSEKLİK HEIGHT (cm)	KAPASİTE Capacity (Lt.)	FİYAT PRICE €
51013000001	32	8	6,40	95,00
51013000002	35	8	8,00	112,50
51013000003	40	10	10,00	137,50
51013000004	45	10	16,00	168,75
51013000005	50	10	20,00	200,00

TABANSIZ KAÇAROLA / CASSEROLE WITHOUT SANDWICH BOTTOM



KOD CODE (MAT/SATIN)	ÇAP DIAMETER (cm)	YÜKSEKLİK HEIGHT (cm)	KAPASİTE Capacity (Lt.)	FİYAT PRICE €
52004000001	16	11	2,20	18,75
52004000002	18	12	3,00	21,25
52004000003	20	13	4,00	23,75
52004000004	24	15	6,70	31,25
52004000005	28	17	10,00	42,50

TABANLI KAÇAROLA / CASSEROLE WITH SANDWICH BOTTOM



KOD CODE (MAT/SATIN)	MODEL Model	YÜKSEKLİK HEIGHT (cm)	KAPASİTE Capacity (Lt.)	FİYAT PRICE €
52001000002	SIĞ	Ø16 x 7	1,40	23,75
52001000004	SIĞ	Ø18 x 8	2,00	27,50
52001000006	SIĞ	Ø20 x 9	2,80	31,25
52001000007	SIĞ	Ø24 x 10	4,50	38,75
52001000009	SIĞ	Ø28 x 12	7,30	52,50
52001000001	DERİN	Ø16 x 11	2,20	25,00
52001000003	DERİN	Ø18 x 12	3,00	27,50
52001000005	DERİN	Ø20 x 13	4,00	30,00
52001000008	DERİN	Ø24 x 15	6,70	46,25
52001000010	DERİN	Ø28 x 17	10,40	58,75

TEK SAPLI KIZARTMA TAVASI / FRYINGPAN WITH SINGLE HANDLE



KOD CODE (MAT/SATIN)	ÇAP Diameter (cm)	YÜKSEKLİK HEIGHT (cm)	KAPASİTE Capacity (Lt.)	FİYAT PRICE €
52009000001	20	4	1,50	26,25
52009000002	24	5	2,00	28,75
52009000003	26	5	2,90	35,00
52009000004	28	6	3,60	43,75
52009000005	32	6	4,80	52,50
52009000006	35	8	10,00	71,25
52009000007	40	8	12,00	87,50

SOTE TAVA PASLANMAZ ÇELİK
S/S SLAUTE PAN



KOD CODE (MAT/SATIN)	ÇAP Diameter (cm)	YÜKSEKLİK HEIGHT (cm)	KAPASİTE Capacity (Lt.)	FİYAT PRICE €
52012000001	16	6	1,00	22,50
52012000002	18	6	1,20	23,75
52012000003	20	6,5	1,60	26,25
52012000004	24	7,5	2,70	31,25

Mutfak Yardımcı Ekipmanları / Kitchen Auxiliary Equipments

YAPIŞMAZ KIZARTMA TAVASI

NON-STICK FRYINGPAN WITH SINGLE HANDLE



KOD Code	ÇAP Diameter (cm)	YÜKSEKLİK Height (cm)	KAPASİTE Capacity (Lt.)	FIYAT PRICE €
52011000003	20	4	1,50	47,50
52011000004	24	5	2,00	56,25
52011000005	26	5	2,90	62,50
52011000006	28	6	3,60	70,00
52011000007	32	6	4,80	81,25
52011000001	35	8	10,00	110,00
52011000002	40	8	12,00	131,25

TEFLON TAVA (ALÜMİNYUM)

TEFLON FRYINGPAN (ALUMINIUM)



KOD Code	ÇAP Diameter (cm)	KAPASİTE Capacity (Lt.)	FIYAT PRICE €
99020130064	20	4,00	36,87 €
99020130065	22	4,00	38,41 €
99020130066	24	5,00	41,48 €
99020130067	26	5,00	46,09 €
99020130068	28	5,50	49,17 €
99020130069	30	5,50	55,31 €
99020130070	32	6,00	60,38 €

TEFLON WOK TAVASI (ALÜMİNYUM)

TEFLON WOK PAN (ALUMINIUM)



KOD Code	ÇAP Diameter (cm)	YÜKSEKLİK Height (cm)	FIYAT PRICE €
99020130055	24	9	49,17 €
99020130056	26	9	54,70 €
99020130057	28	9	60,84 €
99020130058	30	11	66,07 €
99020130059	32	11	71,44 €
99020130060	36	13	106,63 €

TEFLON KREP TAVASI (ALÜMİNYUM)

TEFLON CREPE PAN (ALUMINIUM)



KOD Code	ÇAP Diameter (cm)	FIYAT PRICE €
99020130037	Ø20	35,65 €
99020130038	Ø22	39,33 €
99020130039	Ø24	44,56 €
99020130040	Ø26	49,17 €
99020130041	Ø28	53,78 €
99020130042	Ø30	59,15 €



KUSKUS TENCERESİ
COUSCOUS STCOPOT

KOD Code	MODEL Model	ÇAP Diameter (cm)	DERİNLİK Height (cm)	FİYAT PRICE €
5101500002	Set Kapaklı / Set With Lid	35 x 35 (a)	50 x 20 (b)	312,50
5101500003	Set Kapaklı / Set With Lid	40 x 40 (a)	55 x 20 (b)	375,00
5101500004	Set Kapaklı / Set With Lid	45 x 45 (a)	60 x 20 (b)	500,00
5101500005	Set Kapaklı / Set With Lid	50 x 50 (a)	65 x 25 (b)	687,50
51015000201	Kuskus Süzgeci / Cous Cous Strainer	Ø50	20	162,50
51015000202	Kuskus Süzgeci / Cous Cous Strainer	Ø55	20	187,50
51015000203	Kuskus Süzgeci / Cous Cous Strainer	Ø60	20	231,25
51015000204	Kuskus Süzgeci / Cous Cous Strainer	Ø65	25	287,50



SİLİNDİRİK TENCERE MUSLUKLU TABANLI KAPAKLI
STEW POT WITH TAP WITH BOTTOM WITH LID

KOD Code	ÇAP Diameter (cm)	KAPASİTE Capacity (Lt.)	FİYAT PRICE €
51022000101	Ø 32 x 32	17,00	162,50
51022000102	Ø 35 x 35	35,00	190,00
51022000103	Ø 40 x 40	48,00	243,75
51022000104	Ø 45 x 45	70,00	287,50
51022000105	Ø 50 x 50	95,00	450,00



SEFER TASI PASLANMAZ ÇELİK
MULTI COMP. CARRYING CONTAINER STAINLESS STEEL

KOD Code 304 Kalite	FİYAT PRICE €	KOD Code 430 Kalite	FİYAT PRICE €	ÇAP Diameter (cm)	KAPASİTE Capacity (Lt.)	BÖLÜM Compartment
99090010010	46,25	99090010009	23,00	16	3 x 1,4=4,20	46,25
99090010012	58,75	99090010011	27,00	16	4 x 1,4 = 5,6 0	58,75
99090010015	53,75	99090010014	27,00	18	3 x 2 = 6,00	53,75
99090010017	70,00	99090010016	32,00	18	4 x 2 = 8,00	70,00
99090010020	61,25	99090010019	30,00	20	3 x 3,1 = 9,30	61,25
99090010022	81,25	99090010021	34,00	20	4 x 3,1 = 12,40	81,25
99090010025	75,00	99090010024	33,00	22	3 x 4,8 = 14,40	75,00
99090010027	93,75	99090010026	42,00	22	4 x 4,8 = 19,20	93,75
99090010030	86,25	99090010029	40,00	24	3 x 6,3 = 18,90	86,25
99090010032	113,75	99090010031	48,00	24	4 x 6,3 = 25,20	113,75
99090010034	101,25	99090010037	42,00	26	3 x 7,4 = 22,20	101,25
99090010036	130,00	99090010035	53,00	26	4 x 7,4 = 29,60	130,00
99090010040	121,25	99090010039	49,00	28	3 x 8 = 24,00	121,25
99090010042	141,25	99090010041	62,00	28	4 x 8 = 32,00	141,25
99090010044	93,75	99090010043	40,00	30	2 x 9,8 = 29,40	93,75
99090010046	116,25	99090010045	55,00	30	3 x 9,8 = 39,20	116,25
99090010048	157,50	99090010047	72,00	30	4x9,8=39,20	157,50



MAKARNA SÜZGEÇİ
PASTA STRAINER

KOD Code	MODEL Model	ÇAP Diameter (cm)	YÜKSEKLİK Height	FİYAT PRICE €
51006000013	Tekli / Single	Ø 36	22	88,75
51006000014	Tekli / Single	Ø 40	26	93,75



HELVANE TENCERE KAPAĞI / WIDE POT LID

KOD Code (Parlak)	MODEL	ÇAP (cm)	FİYAT PRICE €
51001000003	HELVANE	30	20,63
51001000004	HELVANE	36	25,00
51001000005	HELVANE	40	33,13
51001000006	HELVANE	45	38,75
51001000007	HELVANE	50	53,75
51001000008	HELVANE	55	61,25
51001000009	HELVANE	60	71,88
51001000010	HELVANE	65	78,75
51001000011	HELVANE	70	82,50
51001000012	HELVANE	80	110,00
51001000013	HELVANE	90	123,75
51001000001	HELVANE	100	151,25
51001000002	HELVANE	110	172,50



SİLİNDİRİK TENCERE KAPAĞI STEW POT LID

KOD Code (Mat)	MODEL	ÇAP (cm)	FİYAT PRICE €
51002000002	SİLİNDİRİK	16	9,38
51002000003	SİLİNDİRİK	18	9,38
51002000004	SİLİNDİRİK	20	10,63
51002000005	SİLİNDİRİK	24	11,88
51002000006	SİLİNDİRİK	28	16,88
51002000007	SİLİNDİRİK	30	22,50
51002000008	SİLİNDİRİK	32	21,88
51002000009	SİLİNDİRİK	35	25,00
51002000010	SİLİNDİRİK	40	31,88
51002000011	SİLİNDİRİK	45	37,50
51002000012	SİLİNDİRİK	50	44,38
51002000013	SİLİNDİRİK	60	65,00



ÇORBALIK KAPAKLI - KULPSUZ POT, WITH LID WITHOUT HANDLE

KOD Code	MODEL	ÇAP (cm)	YÜKSEKLİK (cm)	KAPASİTE Capacity (Lt.)	FİYAT PRICE €
51007000001	TABANLI	Ø 24	24	10,50	65,00
51009000001	TABANSIZ	Ø 24	24	10,50	42,75
51007000002	TABANLI	Ø 28	28	17,20	92,50
51009000002	TABANSIZ	Ø 28	28	17,20	60,75
51007000003	TABANLI	Ø 30	28	19,80	115,00
51009000003	TABANSIZ	Ø 30	28	19,80	84,38
51007000004	TABANLI	Ø 30	32	22,60	130,00
51009000004	TABANSIZ	Ø 30	32	22,60	87,75
51007000005	TABANLI	Ø 32	32	25,70	135,00
51009000005	TABANSIZ	Ø 32	32	25,70	90,00
51007000006	TABANLI	Ø 35	35	33,60	155,00
51009000006	TABANSIZ	Ø 35	35	33,60	106,88
51007000007	TABANLI	Ø 40	40	50,20	187,50
51009000007	TABANSIZ	Ø 40	40	50,20	129,38
51007000008	TABANLI	Ø 45	45	71,50	262,50
51009000008	TABANSIZ	Ø 45	45	71,50	191,25
51007000009	TABANLI	Ø 50	50	98,10	350,00
51009000009	TABANSIZ	Ø 50	50	98,10	303,75



İZOLASYONLU YEMEK TAŞIMA KABI
ISOLATED CARRYING CONTAINER

KOD Code	MODEL Model	ÇAP Diameter (cm)	YÜKSEKLİK Height (cm)	KAPASİTE Capacity (Lt.)	FİYAT PRICE €
53003000007	ÇİFT CİDARLI - DOUBLE WALL	Ø32	10	5	192,50
53003000001	ÇİFT CİDARLI - DOUBLE WALL	Ø32	17	10	210,00
53003000002	ÇİFT CİDARLI - DOUBLE WALL	Ø32	25	15	217,50
53003000003	ÇİFT CİDARLI - DOUBLE WALL	Ø32	30	20	245,25
53003000005	ÇİFT CİDARLI - DOUBLE WALL	Ø35	35	28	270,00
53003000006	ÇİFT CİDARLI - DOUBLE WALL	Ø40	40	42	325,00

YEMEK TAŞIMA KABI
CARRYING CONTAINER



KOD Code	MODEL Model	ÇAP Diameter (cm)	YÜKSEKLİK Height (cm)	KAPASİTE Capacity (Lt.)	FİYAT PRICE €
53004000007	TABANLI - WITH BOTTOM	24	24	11,00	137,50
53005000007	TABANSIZ - WITHOUT BOTTOM	24	24	11,00	97,50
53004000001	TABANLI - WITH BOTTOM	30	28	19,00	156,25
53005000001	TABANSIZ - WITHOUT BOTTOM	30	28	19,00	112,50
53004000002	TABANLI - WITH BOTTOM	30	32	22,00	162,50
53005000002	TABANSIZ - WITHOUT BOTTOM	30	32	22,00	118,13
53004000003	TABANLI - WITH BOTTOM	35	35	33,00	212,50
53005000003	TABANSIZ - WITHOUT BOTTOM	35	35	33,00	168,75
53004000004	TABANLI - WITH BOTTOM	40	40	48,00	250,00
53005000004	TABANSIZ - WITHOUT BOTTOM	40	40	48,00	191,25
53004000005	TABANLI - WITH BOTTOM	45	45	70,00	337,50
53005000005	TABANSIZ - WITHOUT BOTTOM	45	45	70,00	250,00
53004000006	TABANLI - WITH BOTTOM	50	50	95,00	425,00
53005000006	TABANSIZ - WITHOUT BOTTOM	50	50	95,00	325,00



MAYONEZ KABI / MIXING BOWL

KOD Code	EBAT Size (cm)	KAPASİTE Capacity (Lt.)	FİYAT PRICE €
99020140008	Ø24 x 12	4,50	27,00
99020140009	Ø26 x 15	8,00	31,50
99020140010	Ø30 x 17	12,00	37,13
99020140011	Ø36 x 21	22,00	48,38



SELF SERVİS TEPSİSİ / SELF SERVICE TRAY

KOD Code	EBAT Size (mm)	FİYAT PRICE €
55003000002	28 x 40 x 0,60	18,00
55003000003	28 x 40*0,70	19,13
55003000004	28 x 40*0,80	20,25
55003000005	28 x 40*1,00	24,75



ÇELİK SÜRAHİ / STEEL JUG

KOD Code	MODEL Model	LİTRE Liter	FİYAT PRICE €
57004000001	KAPAKLI	1.80	45,00
57004000002	KAPAKSIZ	1.80	30,00



DONDURMA KÜVETİ / GN CONTAINER FOR ICE CREAM

KOD Code	ÇAP Diameter (mm)	YÜKSEKLİK Height (mm)	KAPASİTE Capacity (Lt.)	FİYAT PRICE €
54003000001	365 x 174	120	4,00	27,50
54003000002	365 x 174	150	6,00	30,00



GASTRONORM TEPŞİ / GN TRAY

KOD Code	DIŞ EBAT Size (mm)	YÜKSEKLİK Height (mm)	FİYAT PRICE €
55001000001	530 x 325	1/1 20	18,56
55001000002	530 x 325	1/1 40	22,50
55001000003	530 x 325	1/1 65	24,75
55001000004	325 x 265	1/2 20	11,25
55001000005	325 x 265	1/2 40	12,38
55001000006	325 x 265	1/2 65	13,50
55001000007	650 x 530	2/1 20	37,13
55001000008	650 x 530	2/1 40	42,19
55001000009	650 x 530	2/1 65	48,38
55001000010	354 x 325	2/3 20	13,50
55001000011	354 x 325	2/3 40	17,44
55001000012	354 x 325	2/3 65	19,69

GASTRONORM KÜVETLER
GASTRONORM CONTAINER

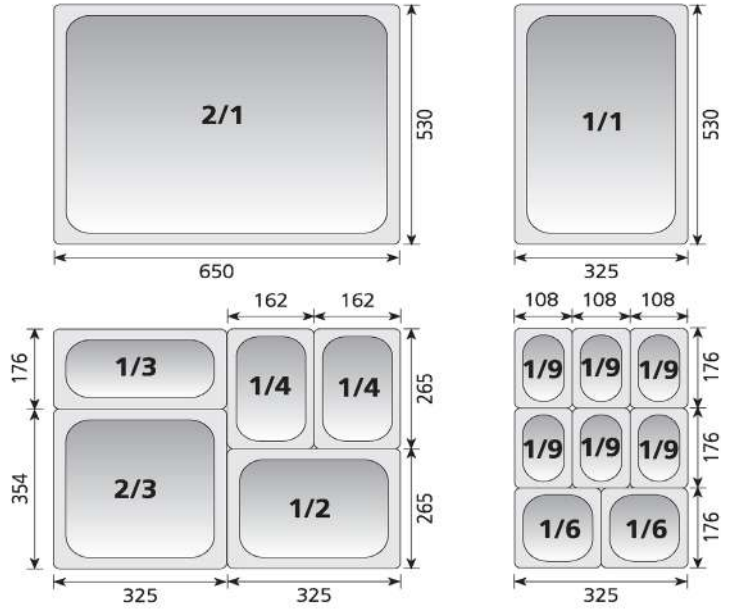

2/1

KOD Code	ÇAP Diameter (mm)	YÜKSEKLİK Height (mm)	KAPASİTE Capacity (Lt.)	FİYAT PRICE €
55014000002	650 x 530	10	TRAY	31,50
54004000030	650 x 530	20	TRAY	34,65
54004000032	650 x 530	40	12,00	37,80
54004000033	650 x 530	65	19,00	42,00
54004000028	650 x 530	100	29,00	50,40
54004000029	650 x 530	150	43,00	77,70
54004000031	650 x 530	200	57,00	86,10



1/1

KOD Code	ÇAP Diameter (mm)	YÜKSEKLİK Height (mm)	KAPASİTE Capacity (Lt.)	FİYAT PRICE €
55014000001	530 x 325	10	TRAY	15,75
54004000001	530 x 325	20	TRAY	16,28
54004000045	530 x 325	40	5,40	16,80
54004000046	530 x 325	65	8,70	18,90
54004000047	530 x 325	100	13,00	24,15
54004000048	530 x 325	150	20,00	31,50
54004000002	530 x 325	200	26,00	40,95



2/3

KOD Code	ÇAP Diameter (mm)	YÜKSEKLİK Height (mm)	KAPASİTE Capacity (Lt.)	FİYAT PRICE €
54004000035	354 x 325	20	TRAY	12,60
54004000037	354 x 325	40	3,40	13,65
54004000038	354 x 325	65	5,50	16,80
54004000034	354 x 325	100	8,40	20,00
54004000049	354 x 325	150	12,00	30,00
54004000036	354 x 325	200	16,00	35,00

Mutfak Yardımcı Ekipmanları / Kitchen Auxiliary Equipments



1/2

KOD Code	ÇAP Diameter (mm)	YÜKSEKLİK Height (mm)	KAPASİTE Capacity (Lt.)	FİYAT PRICE €
54004000006	325 x 265	20	TRAY	9,45
54004000008	325 x 265	40	2,4	10,50
54004000009	325 x 265	65	3,8	12,60
54004000004	325 x 265	100	5,9	17,85
54004000005	325 x 265	150	8,7	18,90
54004000007	325 x 265	200	11	27,83



1/3

KOD Code	ÇAP Diameter (mm)	YÜKSEKLİK Height (mm)	KAPASİTE Capacity (Lt.)	FİYAT PRICE €
54004000012	325 x 176	20	TRAY	10,50
54004000014	325 x 176	40	1,50	10,50
54004000015	325 x 176	65	2,50	10,63
54004000010	325 x 176	100	3,80	15,00
54004000011	325 x 176	150	5,50	22,50
54004000013	325 x 176	200	7,00	30,00



1/4

KOD Code	ÇAP Diameter (mm)	YÜKSEKLİK Height (mm)	KAPASİTE Capacity (Lt.)	FİYAT PRICE €
54004000019	265 x 162	20	TRAY	8,00
54004000016	265 x 162	40	1,20	10,00
54004000021	265 x 162	65	1,70	11,00
54004000017	265 x 162	100	2,70	14,00
54004000018	265 x 162	150	3,80	20,00
54004000020	265 x 162	200	4,80	27,00



1/6

KOD Code	ÇAP Diameter (mm)	YÜKSEKLİK Height (mm)	KAPASİTE Capacity (Lt.)	FİYAT PRICE €
54004000025	176 x 162	65	1,00	7,50
54004000022	176 x 162	100	1,60	10,00
54004000023	176 x 162	150	2,20	15,00
54004000024	176 x 162	200	2,80	18,25



1/9

KOD Code	ÇAP Diameter (mm)	YÜKSEKLİK Height (mm)	KAPASİTE Capacity (Lt.)	FİYAT PRICE €
54004000027	176 x 108	65	0,60	7,00
54004000026	176 x 108	100	0,90	10,75



2/4

KOD Code	ÇAP Diameter (mm)	YÜKSEKLİK Height (mm)	KAPASİTE Capacity (Lt.)	FİYAT PRICE €
54004000041	530 x 162	20	TRAY	10,00
54004000043	530 x 162	40	2,70	14,00
54004000044	530 x 162	65	4,30	17,50
54004000039	530 x 162	100	6,50	20,00
54004000040	530 x 162	150	10,00	28,00

DELİKLİ GASTRONORM KÜVETLER
PERFORATED GASTRONORM CONTAINERS

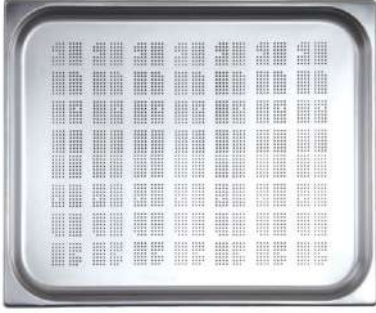

2/1

KOD Code	ÇAP Diameter (mm)	YÜKSEKLİK Height (mm)	FİYAT PRICE €
54006000034	650 x 530	20	39,50
54006000036	650 x 530	40	42,00
54006000037	650 x 530	65	49,88
54006000032	650 x 530	100	60,38
54006000033	650 x 530	150	92,40
54006000035	650 x 530	200	103,95



1/1

KOD Code	ÇAP Diameter (mm)	YÜKSEKLİK Height (mm)	FİYAT PRICE €
54006000004	530 x 325	20	19,95
54006000006	530 x 325	40	23,10
54006000007	530 x 325	65	24,15
54006000002	530 x 325	100	30,45
54006000003	530 x 325	150	42,00
54006000005	530 x 325	200	56,70



2/3

KOD Code	ÇAP Diameter (mm)	YÜKSEKLİK Height (mm)	FİYAT PRICE €
54006000040	354 x 325	20	15,75
54006000042	354 x 325	40	18,38
54006000043	354 x 325	65	21,00
54006000038	354 x 325	100	24,15
54006000039	354 x 325	150	38,33
54006000041	354 x 325	200	44,10



1/2

KOD Code	ÇAP Diameter (mm)	YÜKSEKLİK Height (mm)	FİYAT PRICE €
54006000011	325 x 265	20	14,18
54006000013	325 x 265	40	15,23
54006000014	325 x 265	65	16,28
54006000009	325 x 265	100	18,38
54006000010	325 x 265	150	26,78
54006000012	325 x 265	200	36,50



1/3

KOD Code	ÇAP Diameter (mm)	YÜKSEKLİK Height (mm)	FİYAT PRICE €
54006000018	325 x 176	20	14,18
54006000020	325 x 176	40	15,23
54006000021	325 x 176	65	17,85
54006000016	325 x 176	100	24,15
54006000017	325 x 176	150	32,03
54006000019	325 x 176	200	38,33



1/4

KOD Code	ÇAP Diameter (mm)	YÜKSEKLİK Height (mm)	FİYAT PRICE €
99010030064	265 x 162	20	15,75
99010030066	265 x 162	40	17,85
99010030067	265 x 162	65	21,00
99010030062	265 x 162	100	24,15
99010030063	265 x 162	150	25,00
99010030065	265 x 162	200	30,00



GN SÜZGEÇ GN STRAINER

KOD Code	MODEL	FİYAT PRICE €
54015000001	1/1 - h15 mm	26,78
54015000002	1/2 - h15 mm	19,95
54015000003	1/3 - h15 mm	16,28
54015000004	2/1 - h15 mm	47,25



GLASO TELİ / (PASLANMAZ TEL IZGARA) STAINLESS STEEL GRID

KOD Code	EBAT Size (mm)	FİYAT PRICE €
99010010002	1/1 530 x 325	24,15
99010010004	1/2 325 x 265	15,75
99010010006	2/1 650 x 530	38,85
99010010011	400 x 600	30,45
99010010008	2/3 354 x 325	18,90



GN ÇUBUK GN BAR

KOD Code	EBAT Dimen.sion (cm)	UZUNLUK Length (cm)	FİYAT PRICE €
54002000004	1/1 EBAT / Size	53	4,73
54002000003	1/2 EBAT / Size	32,5	4,73
54002000002	1/3 EBAT / Size	17,6	3,68
54002000001	1/4 EBAT / Size	16,2	3,68

ÇİFT SAPLI GASTRONORM KÜVETLER

GASTRONORM CONTAINER WITH DOUBLE HANDLE



2/1	KOD Code	ÇAP Diameter (mm)	YÜKSEKLİK Height (mm)	KAPASİTE Capacity (Lt.)	FİYAT PRICE €
	54005000026	650 x 530	65	19,00	41,48
	54005000024	650 x 530	100	29,00	42,00
	54005000001	650 x 530	150	43,00	57,00
	54005000025	650 x 530	200	57,00	74,00



1/1	KOD Code	ÇAP Diameter (mm)	YÜKSEKLİK Height (mm)	KAPASİTE Capacity (Lt.)	FİYAT PRICE €
	54005000005	530 x 325	65	8,70	25,73
	54005000002	530 x 325	100	13,00	28,88
	54005000003	530 x 325	150	20,00	36,96
	54005000004	530 x 325	200	26,00	48,83



2/3	KOD Code	ÇAP Diameter (mm)	YÜKSEKLİK Height (mm)	KAPASİTE Capacity (Lt.)	FİYAT PRICE €
	54005000030	354 x 325	65	5,50	22,05
	54005000027	354 x 325	100	8,40	27,83
	54005000028	354 x 325	150	12,00	37,28
	54005000029	354 x 325	200	16,00	43,05



1/2	KOD Code	ÇAP Diameter (mm)	YÜKSEKLİK Height (mm)	KAPASİTE Capacity (Lt.)	FİYAT PRICE €
	54005000009	325 x 265	65	3,80	18,38
	54005000006	325 x 265	100	5,90	22,05
	54005000007	325 x 265	150	8,70	28,88
	54005000008	325 x 265	200	11,00	36,75



1/3	KOD Code	ÇAP Diameter (mm)	YÜKSEKLİK Height (mm)	KAPASİTE Capacity (Lt.)	FİYAT PRICE €
	54005000013	325 x 176	65	2,50	16,28
	54005000010	325 x 176	100	3,80	19,95
	54005000011	325 x 176	150	5,50	27,83
	54005000012	325 x 176	200	7,00	33,60



1/4	KOD Code	ÇAP Diameter (mm)	YÜKSEKLİK Height (mm)	KAPASİTE Capacity (Lt.)	FİYAT PRICE €
	54005000017	265 x 162	65	1,80	15,23
	54005000014	265 x 162	100	2,70	17,33
	54005000015	265 x 162	150	3,80	25,73
	54005000016	265 x 162	200	4,80	28,88

1/6	KOD Code	ÇAP Diameter (mm)	YÜKSEKLİK Height (mm)	KAPASİTE Capacity (Lt.)	FİYAT PRICE €
	54005000021	176 x 162	65	1,00	12,60
	54005000018	176 x 162	100	1,60	15,23
	54005000019	176 x 162	150	2,20	19,95
	54005000020	176 x 162	200	2,80	24,15



GASTRONORM KÜVET KAPAĞI
GN CONTAINER LID

KOD Code	EBAT Size	FİYAT PRICE €
54013000007	GN 2/1	35,00
54013000008	GN 1/1	16,28
54013000009	GN 2/3	13,65
54013000002	GN 1/2	10,50
54013000003	GN 1/3	10,50
54013000004	GN 1/4	7,50
54013000005	GN 1/6	7,50
54013000006	GN 1/9	5,50
54013000001	GN 2/4	12,60



KEPÇE DELİKLİ GN KÜVET KAPAĞI
GN CONTAINER LID SLOTTED FOR LADLE

KOD Code	MODEL	EBAT Size (mm)	FİYAT PRICE €
54012000001	1/1	530 x 325	18,67
54012000002	1/2	325 x 265	14,00
54012000003	1/3	325 x 176	14,00
54012000004	1/4	265 x 162	14,00
54012000005	1/6	176 x 162	11,67
54012000006	2/4	530 x 170	16,33



GN ÇİFT SAP DELİKLİ KÜVET KAPAĞI
GN CONTAINER LID WITH DOUBLE HANDLE

KOD Code	MODEL	EBAT Size (mm)	FİYAT PRICE €
54011000007	2/1	530 x 650	37,33
54011000001	1/1	530 x 325	18,67
54011000008	2/3	354 x 325	18,67
54011000002	1/2	325 x 265	16,33
54011000003	1/3	325 x 176	14,00
54011000004	1/4	265 x 162	14,00
54011000005	1/6	176 x 162	11,67



SİLİKONLU GASTRONORM KÜVET KAPAĞI
GN CONTAINER LID WITH SILICON FRAME

KOD Code	EBAT Size (mm)	FİYAT PRICE €
54010000006	GN 2/1	87,50
54010000001	GN 1/1	40,00
54010000002	GN 1/2	30,00
54010000003	GN 1/3	30,00
54010000004	GN 1/4	25,00
54010000005	GN 1/6	25,00
54010000007	GN 2/3	35,00



KLİPSLİ - KULPLU FIRIN TEPSİSİ KAPAKLI
OVEN TRAY WITH LOCK - HANDLE WITH LID

KOD Code	EBAT Size (cm)	KAPASİTE Capacity (Lt.)	FİYAT PRICE €
55008000003	35 x 45 x 8	11,00	83,25
55008000002	40 x 60 x 8	19,20	106,88
55008000004	45 x 60 x 8	21,00	111,38
55008000005	50 x 70 x 8	28,00	142,88
55008000006	50 x 70 x 10	35,00	163,13



FIRIN TEPSİSİ KAPAKSIZ / OVEN TRAY WITHOUT LID

KOD Code	EBAT Size (cm)	KAPASİTE Capacity (Lt.)	FİYAT PRICE €
55007000001	35 x 45 x 5	6,30	37,13
55007000002	35 x 45 x 8	11,00	41,06
55007000003	40 x 60 x 5	12,00	50,63
55007000004	40 x 60 x 8	19,20	57,38
55007000005	45 x 60 x 5	13,50	54,56
55007000006	45 x 60 x 8	21,00	60,75
55007000008	50 x 70 x 5	14,00	72,00
55007000009	50 x 70 x 8	28,00	78,19
55007000007	50 x 70 x 10	35,00	88,88
55007000010	60 x 80 x 2	9,60	271,13



TEFLONLU FIRIN TEPSİSİ KAPAKSIZ
NON STICK TEFLON TRAY WITHOUT LID

KOD Code	EBAT Size (cm)	KAPASİTE Capacity (Lt.)	FİYAT PRICE €
55011000001	35 x 45 x 5	6,30	53,44
55011000002	35 x 45 x 8	11,00	61,88
55011000004	40 x 60 x 5	13,50	74,25
55011000006	40 x 60 x 8	21,00	84,38
55011000008	45 x 60 x 5	13,50	80,44
55011000009	45 x 60 x 8	21,00	88,88
55011000011	50 x 70 x 5	14,00	101,25
55011000012	50 x 70 x 8	28,00	120,38
55011000010	50 x 70 x 10	35,00	146,25



FIRIN TEPSİ KAPAĞI / LID FOR OVEN TRAY

KOD Code	EBAT Size (cm)	FİYAT PRICE €
55002000001	35 x 45	24,75
55002000002	40 x 60	33,75
55002000003	45 x 60	36,00
55002000004	50 x 70	43,88

REYON TEPSİSİ / RAYON TRAY

KOD Code	EBAT Size (mm)	FİYAT PRICE €
55016000001	250 x 400*20	27,00
55016000002	250 x 400*40	43,31
55016000003	250 x 800*20	43,31
55016000004	250 x 800*40	49,50

LOKANTA TEPSİSİ / RESTAURANT TRAY

KOD Code	EBAT Size (mm)	FİYAT PRICE €
55014000003	300 x 500 x 1,5	23,63
55014000004	350 x 450 x 1,5	25,88
55014000005	450 x 600 x 1,5	36,00
55014000006	500 x 700 x 1,5	46,13

PASTACI TEPSİSİ / PASTRY TRAY

KOD Code	EBAT Size (mm)	FİYAT PRICE €
55015000001	100 x 300	6,19
55015000002	150 x 300	7,31
55015000003	200 x 300	9,00
55015000004	250 x 400	12,38
55015000005	300 x 500	18,56

PASLANMAZ ÇELİK PATİSERİ FIRIN TEPSİSİ KAPAKSIZ STAINLESS STEEL PATISSERIE OVEN TRAY WITHOUT LID

KOD Code	MODEL	EBAT Size (cm)	FİYAT PRICE €
55017000001	Paslanmaz Çelik / S/S	40 x 60 x 2,5	45,00
55017000002	Paslanmaz Çelik / S/S	40 x 60 x 6	47,25
55017010001	Yapışmaz / Non-Stick	40 x 60 x 2,5	68,63
55017010003	Yapışmaz / Non-Stick	40 x 60 x 6	80,44

Servis Ekipmanları

Service Equipments



www.kayalarmutfak.com.tr

444 5 957



Servis Ekipmanları / Service Equipments



180° AÇILIR KAPAKLI REŞO
CHAFING DISH WITH 180° ROLL TOP LID

KOD Code	MODEL Model	ISITMA TİPİ Heated Type	EBAT Size (mm)	GN KAPASİTE Capacity GN (Lt.)	FİYAT PRICE €
59002000003	STANDART	ELEKTRİKLİ	670 x 490 x 440	GN 1/1-65	627,75
59002000006	STANDART	JEL / GEL	670 x 490 x 440	GN 1/1-65	517,50



ANKASTRE 180° AÇILIR KAPAKLI REŞO
CHAFING DISH WITH 180° ROLL TOP LID BUILD IN

KOD Code	MODEL Model	ISITMA TİPİ Heated Type	EBAT Size (mm)	GN KAPASİTE Capacity GN (Lt.)	FİYAT PRICE €
59002000004	ANKASTRE	ELEKTRİKLİ	670 x 490 x 440	GN 1/1-65	556,88



180° AÇILIR KAPAKLI REŞO ÇORBALIK
CHAFING DISH WITH 180° ROLL TOP LID FOR 2 SOUP BOWLS

KOD Code	MODEL Model	ISITMA TİPİ Heated Type	EBAT Size (mm)	GN KAPASİTE Capacity GN (Lt.)	FİYAT PRICE €
59002000001	2' Lİ ÇORBALIK	ELEKTRİKLİ	670 x 490 x 440	5,5 + 5,5 lt	765,00
59002000002	2' Lİ ÇORBALIK	JEL / GEL	670 x 490 x 440	5,5 + 5,5 lt	630,00



ANKASTRE 180° AÇILIR KAPAKLI CHAFING DISH ÇORBALIK
CHAFING DISH WITH 180° ROLL TOP LID FOR 2 BUILD IN

KOD Code	MODEL Model	ISITMA TİPİ Heated Type	EBAT Size (mm)	GN KAPASİTE Capacity GN (Lt.)	FİYAT PRICE €
59002000019	ANKASTRE / Built In	ELEKTRİKLİ	670 x 490 x 440	5,5 + 5,5 lt	714,38



180° AÇILIR KAPAKLI YUVARLAK REŞO / ÇORBALIK
ROUND CHAFING DISH WITH 180° ROLL TOP LID SOUP SERVER

KOD Code	MODEL Model	ISITMA TİPİ Heated Type	EBAT Size (mm)	GN KAPASİTE Capacity GN (Lt.)	FİYAT PRICE €
59006000001	ÇORBALIK	ELEKTRİKLİ	500 x 510 x 550	5,50	646,88
59006000004	ÇORBALIK	JEL / GEL	500 x 510 x 550	5,50	536,63



ANKASTRE 180° AÇILIR KAPAKLI CHAFING DISH
CHAFING DISH WITH 180° ROLL TOP LID BUILT IN

KOD Code	MODEL Model	ISITMA TİPİ Heated Type	EBAT Size (mm)	GN KAPASİTE Capacity GN (Lt.)	FİYAT PRICE €
59006000002	ANKASTRE / Built In	ELEKTRİKLİ	500 x 510 x 550	5,50	556,88



180° AÇILIR KAPAKLI YUVARLAK REŞO
ROUND CHAFING DISH WITH 180° ROLL TOP LID

KOD Code	MODEL Model	ISITMA TİPİ Heated Type	EBAT Size (mm)	GN KAPASİTE Capacity GN (Lt.)	FİYAT PRICE €
59006000008	STANDART	ELEKTRİKLİ	500 x 510 x 550	9,00	582,75
59006000009	STANDART	JEL / GEL	500 x 510 x 550	9,00	517,50



ANKASTRE 180° AÇILIR KAPAKLI YUVARLAK CHAFING DISH
CHAFING DISH WITH 180° ROLL TOP LID BUILT IN

KOD Code	MODEL Model	ISITMA TİPİ Heated Type	EBAT Size (mm)	GN KAPASİTE Capacity GN (Lt.)	FİYAT PRICE €
59006000007	ANKASTRE / Built In	ELEKTRİKLİ	500 x 510 x 550	9,00	517,50

Servis Ekipmanları / Service Equipments



DÜZ KAPAKLI PLASTİK SAPLI REŞO
CHAFING DISH STANDART LID

KOD Code	ISITMA TİPİ Heated Type	EBAT Size (mm)	GN KAPASİTE Capacity GN (lt)	KAPASİTE Capacity (Lt.)	FİYAT PRICE €
59002000009	JEL / GEL	650 x 360 x 250	GN 1/1-65	9,00	315,00
59002000008	ELEKTRİKLİ	650 x 360 x 250	GN 1/1-65	9,00	382,50



ROLL TOP KAPAKLI REŞO
CHAFING DISH WITH ROLL TOP LID WITH PLASTIC HANDLE

KOD Code	ISITMA TİPİ Heated Type	EBAT Size (mm)	GN KAPASİTE Capacity GN (lt)	KAPASİTE Capacity (Lt.)	FİYAT PRICE €
59002000014	JEL / GEL	650 x 350 x 450	GN 1/1-65	9,00	326,25
59002000013	ELEKTRİKLİ	650 x 350 x 450	GN 1/1-65	9,00	405,00



DÜZ KAPAKLI İSTİFLENEBİLİR EKO MODEL REŞO
CHAFING DISH STANDART LID ECONOMIC

KOD Code	ISITMA TİPİ Heated Type	EBAT Size (cm)	KAPASİTE Capacity (Lt.)	FİYAT PRICE €
59002000010	JEL / GEL	630 x 320 x 220	9,00	247,50



ROLL TOP KAPAKLI EKONOMİK REŞO
ECONOMIC CHAFING DISH WITH ROLL TOP LID ECONOMIC

KOD CODE	ISITMA TİPİ Heated Type	EBAT DIMENSION (mm)	GN KAPASİTE CAPACITY GN (lt)	KAPASİTE CAPACITY (Lt.)	FİYAT PRICE €
59002000015	JEL / GEL	630 x 320 x 340	GN 1/1-65	9,00	270,00



REŞO PARÇALARI SPARE PARTS

KOD Code	YEDEK PARÇA Spare Parts	FİYAT PRICE €
10040210050	Reşo Pleyt (Termostatlı)	112,50
B0013000003	Reşo Yakıt Kabı	14,63
B0013000031	Reşo Suluk	61,88
B0013000025	Reşo Kapak (Düz - Standart)	90,00
B0013000039	Reşo Kapak Roltop	112,50



TABAK KAPAĞI / COVER PLATE

KOD Code	MODEL	EBAT Size (Cm)	FİYAT PRICE €
55004000001	DELİKLİ	Ø 27,5	16,00
55005000001	KULPLU	Ø 27,5	16,00
55004000002	DELİKLİ	Ø 28,5	16,50
55004000005	DELİKLİ	Ø 29,5	17,00
55005000003	KULPLU	Ø 29,5	17,00
55004000004	KULPLU	Ø 32,0	17,50



PREMIUM ETHANOL REŞO YAKITLARI PREMIUM ETHANOL GEL

KOD Code	YAKIT TİPİ Gel Type	KAPASİTE Capacity	FİYAT PRICE €
99040030001	Tin. Can	200,00 gr	1,25
99040030002	Plastic Bucket	4,00 kg	25,00

Servis Ekipmanları / Service Equipments



MAKARNA MAŞASI / SPAGHETTI TONG

KOD Code	UZUNLUK Length (cm)	FİYAT PRICE €
99020070023	22	6,25



SALATA MAŞASI / SALAD TONG

KOD Code	UZUNLUK Length (cm)	FİYAT PRICE €
99020070027	22,00	6,25



PASTA MAŞASI / CAKE TONG

KOD Code	UZUNLUK Length (cm)	FİYAT PRICE €
99020070025	21,50	6,25



ŞEKER MAŞASI / SUGAR TONG

KOD Code	UZUNLUK Length (cm)	FİYAT PRICE €
99020070030	12,00	6,25



BUZ MAŞASI / ICE TONG

KOD Code	UZUNLUK Length (cm)	FİYAT PRICE €
99020070013	16,00	6,25



IZGARA MAŞASI / GRILL TONG

KOD Code	UZUNLUK Length (cm)	FİYAT PRICE €
99020070015	32,50	7,50
99020070022	27,00	6,25
99020070020	24,50	6,25

SANAYİ TİPİ KEPÇE / HEAVY DUTY LADLE



KOD Code	MODEL NO	AĞIZ GENİŞLİĞİ Edge Wideness (cm)	SAP UZUNLUK Handle Length (cm)	FİYAT PRICE €
99020060011	(NO:1)	8,00	33,00	8,38
99020060013	(NO:2)	9,00	36,00	9,25
99020060014	(NO:3)	10,00	42,50	11,63
99020060015	(NO:4)	11,00	47,50	14,00
99020060016	(NO:5)	13,50	57,00	18,75
99020060017	(NO:6)	15,50	62,50	26,88
99020060018	(NO:7)	18,00	70,00	40,00
99020060019	(NO:8)	20,50	80,00	50,00
99020060020	(NO:9)	23,00	90,00	65,00
99020060012	(NO:10)	25,50	100,00	80,00

SANAYİ TİPİ KEVGİR / HEAVY DUTY SKIMMER



KOD Code	MODEL NO	AĞIZ GENİŞLİĞİ Edge Wideness (cm)	SAP UZUNLUK Handle Length (cm)	FİYAT PRICE €
99020060029	(NO:1)	9,00	33,00	8,38
99020060031	(NO:2)	10,5	33,00	9,25
99020060032	(NO:3)	11,00	42,50	11,63
99020060033	(NO:4)	12,50	47,50	14,00
99020060034	(NO:5)	15,00	57,00	18,75
99020060035	(NO:6)	17,50	62,50	26,88
99020060036	(NO:7)	19,00	70,00	40,00
99020060037	(NO:8)	23,00	80,00	50,00
99020060038	(NO:9)	25,10	90,00	65,00
99020060030	(NO:10)	28,00	100,00	80,00

SERVIS KAŞIK / SERVING SPOON



KOD Code	MODEL	SAP UZUNLUK Handle Length (cm)	AĞIZ GENİŞLİĞİ Edge Wideness (cm)	FİYAT PRICE €
99110020174	DÜZ - SMOOTH	NO : 2	6,30	11,38
99110020173	DELİKLİ - PERFORATED	NO : 2	6,30	10,38
99110090014	SOS KEPÇE - SAUCE LADLE	NO : 3	-	11,38
99110090012	SOS KEPÇE - SAUCE LADLE	No : 4	-	12,13

SERVIS SPATULA / SERVING SPATULA

KOD Code	MODEL	SAP UZUNLUK Handle Length (cm)	AĞIZ GENİŞLİĞİ Edge Wideness (cm)	FİYAT PRICE €
99110180007	NO : 1	28,50	8,00	11,38
99110180008	NO : 2	41,00	8,00	11,38

Servis Ekipmanları / Service Equipments



THERMO TEPİ İZOLASYONLU THERMO TRAY ISOLATED

KOD Code	MODEL Model	EBAT Size (mm)	FİYAT PRICE €
99110160012	6 GÖZLÜ TABAKSIZ Without Plate	540 x 380 x 100	112,50
23 cm Düz Tabak ya da 20 cm Çukur Tabak 17 cm Kare Kayık Tabak ya da 12 cm Joker Kase 14 cm Kare Kayık Tabak - Fincan - 12 cm Joker Kase 17 cm Kare Kayık Tabak ya da 12 cm Joker Kase			
Porselenler FİYATA Dahil Değildir.			



THERMOBOX

KOD Code	MODEL Model	DIŞ EBAT Ext. Dim. (mm)	İÇ EBAT Int. Dim. (mm)	KAPASİTE Capacity (Lt.)	FİYAT PRICE €
99090020002	600	620 x 430 x 660	540 x 330 x 510	90	350,00
99090020001	300	620 x 420 x 400	530 x 325 x 200	35	312,50

ÜRÜN ÖZELLİKLERİ

- *Bulaşık makinesinde yıkanabilir.
- *+100°C sığağa, -40°C soğuga dayanıklıdır.
- *Ürün iç yüzeyinin kolay temizlenebilmesi ve hijyenik olabilmesi için parlak ve pürüzsüzdür.
- *Ekstra güçlendirilmiş köşe yapısına sahiptir.
- *53 lt - 63 lt arasında taşıma kapasitesine sahiptir.
- *Üst üste dizilebilir.
- *Hafif gövde yapısı sayesinde taşıma kolaylığı sağlar.
- *İnsan sağlığına zararlı madde içermemektedir.
- *Talebe göre renk seçenekleriyle üretilebilir.
- *Kapak gövdeden bağımsızdır.Yükleme kolaylığı sağlar.

PRODUCT SPECIFICATIONS

- *Dishwasher safe
- *Can withstand temperatures from -40 °C to 100°C
- *Smooth inside surface that hygienic and easy to clean
- *Features tough reinforced corners
- *Can carry from 53lt to 63lt
- *Light case that is easy to lift
- *Stackable
- *Double walls filled with polyurethane foam
- *Does not contain any substances harmful to human health



THERMO TEPİ TAŞIMA ARABASI THERMO TRAY CARRYING TROLLEY

KOD Code	KAPASİTE Capacity	EBAT Size (mm)	FİYAT PRICE €
99110230014	15 ADET	620 x 800 x 108	500,00
2 ADET GN 1/4 KÜVET DAHİLDİR.			

THERMO TEPİLER FİYATA DAHİL DEĞİLDİR.
THERMO TRAYS ARE NOT INCLUDED TO THE PRICES

LAMİNE SELF SERVİS TEPŞİ LAMINATED SELF SERVING TRAY



KOD Code	MODEL	EBAT Size (cm)	KALINLIK Size (mm)	FİYAT PRICE €
99110220150	LAMİNE SELF SERVİS TEPŞİSİ (Eco)	37 x 53	2,00	15,00
99110220100	LAMİNE SELF SERVİS TEPŞİSİ	32 x 42	2,00	13,75
99110220111	LAMİNE SELF SERVİS TEPŞİSİ	Ø43,5	2,00	18,75
99110220107	LAMİNE SELF SERVİS TEPŞİSİ	43 x 61	2,00	22,50
99110220149	LAMİNE SELF SERVİS TEPŞİSİ	36 x 46	2,30	16,25
99110220102	KAYMAZ LAMİNE SERVİS TEPŞİSİ (Eco) - NON-SLIP	37 x 53	2,30	17,50
99110220099	KAYMAZ LAMİNE SERVİS TEPŞİSİ - NON-SLIP	32 x 42	2,30	16,25
99110220110	KAYMAZ LAMİNE SERVİS TEPŞİSİ - NON-SLIP	Ø43	2,30	21,25
99110220160	KAYMAZ LAMİNE SERVİS TEPŞİSİ - NON-SLIP	Ø38	2,30	16,25

POLİETİLEN KESME TAHTASI POLYETHYLENE CUTTING BOARD



KOD Code	EBAT / Size (cm)	FİYAT PRICE €
99080020015	30 x 50 x 2	21,76 €
99080020016	30 x 50 x 4	43,51 €
99080020037	50 x 70 x 4	34,81 €
99080020028	40 x 60 x 4	69,62 €
99080020025	60 x 40 x 2	72,46 €
99080020033	50 x 50 x 4	101,41 €

Özel Ölçüye göre sipariş alınır

PASLANMAZ ÇÖP ARABASI / STAINLESS WASTE TROLLEY



KOD Code	MODEL	EBAT Size (mm)	KAPASİTE Capacity (Lt.)	FİYAT PRICE €
40500000001001	PEDALSIZ - W.OUT PEDAL	Ø 40 x 40	49,00	208,13
40500000001002	PEDALSIZ - W.OUT PEDAL	Ø 45 x 45	71,00	247,50
40500000001003	PEDALSIZ - W.OUT PEDAL	Ø 50 x 50	96,00	281,25

Servis Ekipmanları / Service Equipments



ÇAY MAKİNESİ TEA MAKER

KOD Code ÇİFT Göstergeli	HACİM Volume (lt)	KAPASİTE Capacity (Bardak)	ÇALIŞMA ISISI Operating Temperature (kg/h)	VOLTAJ Voltage (V)	GÜÇ Power (kw)	FİYAT PRICE €
58001000007	5	50,00	85	220	0,90	150,00
58001000011	7	70,00	85	220	1,20	150,00
58001000013	9	90,00	85	220	1,50	170,00
58001000001	13	130,00	85	220	1,50	180,00
58001000002	17	170,00	85	220	2,00	200,00
58001000004	23	230,00	85	220	2,00	235,00
58001000005	35	350,00	85	220	3,00	325,00
58001000009	50	500,00	85	220	4,00	362,50

SU ISITICI HOT WATER DISPENSER



KOD Code	HACİM Volume (lt)	KAPASİTE Capacity (Bardak)	ÇALIŞMA ISISI Operating Temperature (kg/h)	VOLTAJ Voltage (V)	GÜÇ Power (kw)	FİYAT PRICE €
58003000005	5,00	50,00	85	220	0,90	98,00
58003000007	7,00	70,00	85	220	1,20	105,00
58003000009	9,00	90,00	85	220	1,50	110,00
58003000001	13,00	130,00	85	220	1,50	120,00
58003000002	17,00	170,00	85	220	2,00	130,00
58003000003	23,00	230,00	85	220	2,00	175,00
58003000004	35,00	350,00	85	220	3,00	225,00
58003000006	50,00	500,00	85	380	4,50	295,00

FİLTRE KAHVE MAKİNESİ FILTER COFFEE MACHINE



KOD Code	HACİM Volume (lt)	KAPASİTE Capacity (Bardak)	VOLTAJ Voltage (V)	GÜÇ Power (kw)	FİYAT PRICE €
58002000001	13,00	100,00	220	1,64	225,00
58002000002	23,00	200,00	220	2,20	275,00



FIELD KITCHENS



Sahra Mutfak / Field Kitchen





Kayalar field kitchen are designed and produced for providing hot meal to soldiers. It's a catering system designed for mobile applications with the armed force, civil defence and disaster control organizations. The oven, pots and pans which are in the mobile kitchen unit are designed as they can be taken of their places and they can be also used in stable facilities. Each cooking unit operates independently different meals can be prepared at the same time.



Transportation Options



Aircraft



Truck



Ship

Color Options

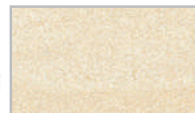

BeigeK



Haki



Camouflage

All colours available after gives Ral code.

KYL-01

600 Person

- 1- Axle and Puller Barb
- 2- Base Frame
- 3- Vehicle Side Cabinet
- 4- Upper Protection and Tent
- 5- Gas and Fire Extinguishing System
- 6- Electric and water system
- 7- Oven
- 8- Frying Pan
- 9- Burning System (Diesel, Gas or Kerosene)
- 10- Water Boiler

Cooking Equipments

Pressure Boiling Pan 180 Lt : 2 Pcs
Frying Pan 80 Lt : 2 pcs
Oven (3 x 2/1 Gn 70 Lt : 2 Pcs
Hot Water Unit 35 Lt : 2 Pcs

Burners

Multi Burner : 2 Pcs
Solid Fuel Burner : 2 Pcs

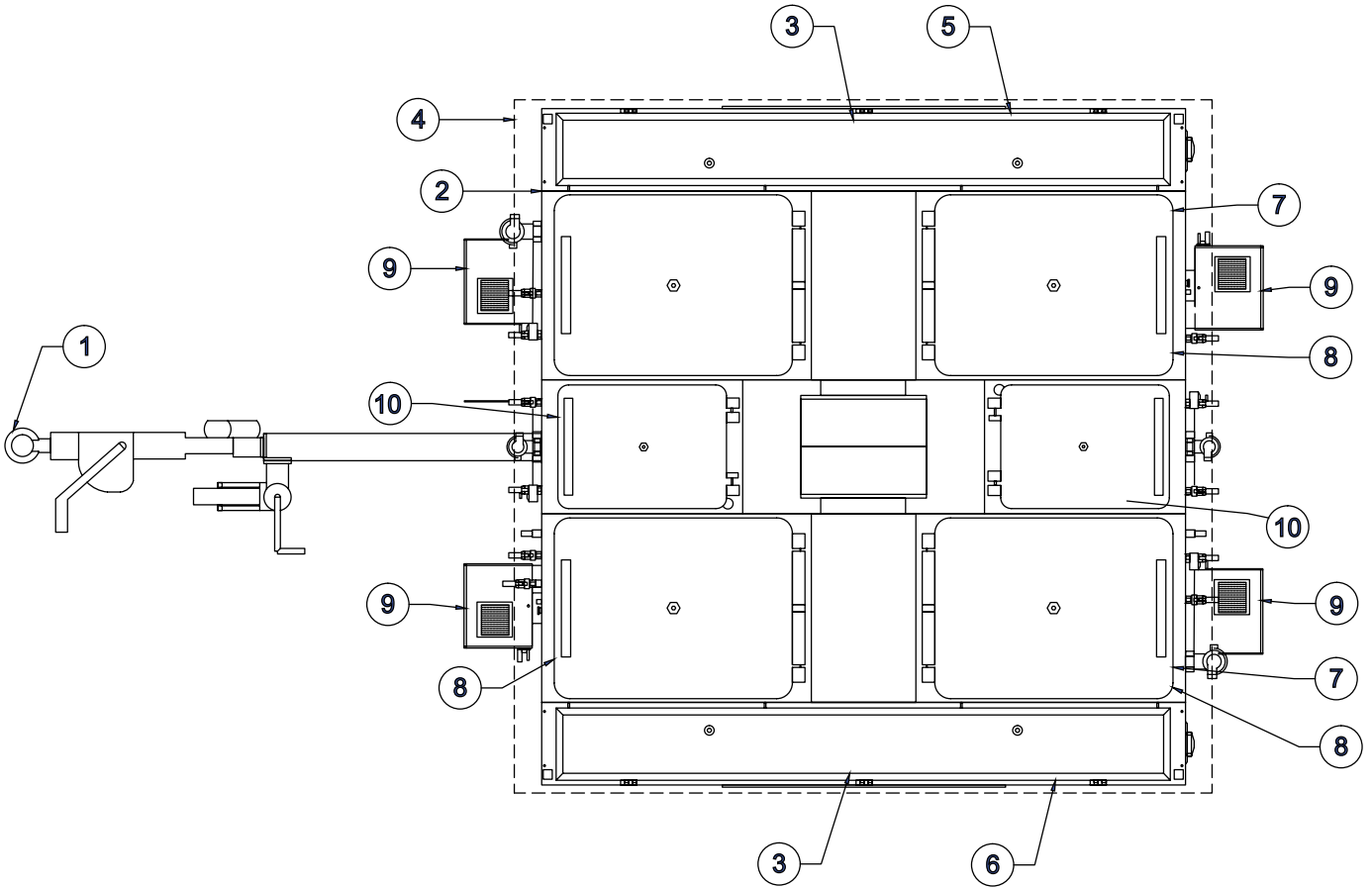

Cooking Methods

Pressure Boiling Pan : Stewing, Pressure Cooker, Boiling, Steaming

Frying Pan : Stewing, Grilling, Frying, Roasting, Boiling

Fryer : Stewing, Grilling, Frying, Boiling, Steaming

Oven : Stewing, Baking

Hot Water Unit : Boiling

Couscous Cooker (Steam Cooker) : Stewing, Pressure Cooker, Steaming



Model No : KYL-01
Net Weight : approx. 1950 Kg.
Overall Length : 3730 mm
Overall Width : 2235 mm
Overall Height : approx. 2600 mm
Height of work surface, empty : 1050 mm
Height of work surface, loaded : 1000 mm
Length of work surface : 1900 mm
Ground Clearance : 300 mm

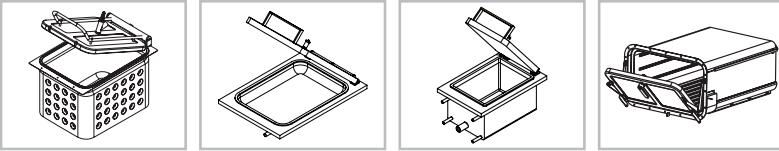

Cooking Unit	Meal Speciality	Cooking Time	Cooking Capacity	Portion Size
Frying Pan	Fried Vegetable	30 Min.	100 Person	70 - 80 gr.
	Fried Meat	30-60 Min.	100 Person	200 gr.
	Fried Chicken	30 Min	100 Person	200 - 250 gr.
Boiling Pan	Soup	60 Min.	600 Person	200 - 250 gr.
	Rice	45 Min.	600 Person	300 gr.
	Hotplate	It depends on the speciality of the food		
Oven	Meat	120 Min.	100 Person	200 gr.
	Chicken	120 Min.	100 Person	200 gr.
	Vegetable	120 Min.	100 Person	200 gr.
	Bread	120 Min.	100 Person	150 gr.
Hot Water	Tea	60 Min.	100 Person	1 Cup
	Water	60 Min.	100 Person	1 Cup

AXLE

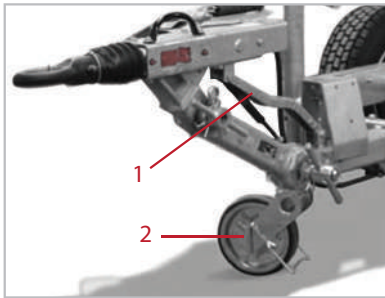
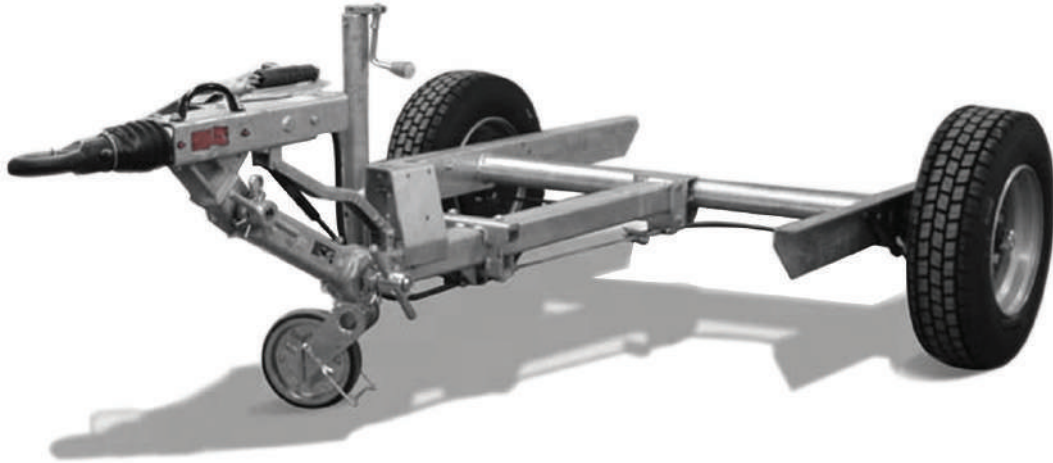

1- Hand Brake
2 - Jockey Wheel

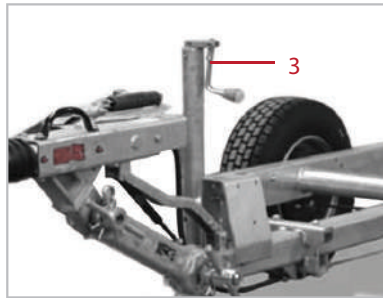

3 - Jockey wheel adjustment arm

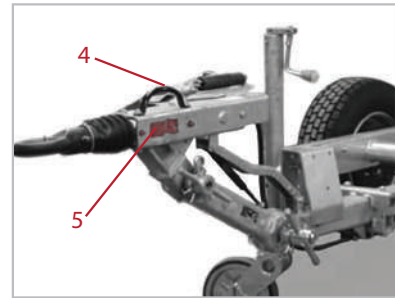

4 - Electrical Connection Socket
5 - Safety break arm

Field kitchen is mounted on a single axle trailer. The rubber torsion axle supported with two shock absorbers provides a comfortable drive. Field kitchen can be towed with any military or civil vehicle easily by the height adjustable coupling ring. The drawbar of the Field kitchen is equipped with a hand brake damper having 3 000 kg's load capacity. If the kitchen and the towing vehicle gets disconnected by accident, trailer brakes will be activated by the cable of safety break, safety transportation is ensured by automatic break system.

Generator



Engine Type : 4 Stroke Diesel
Cooling System : Air Cooled
Oil Storage Capacity : 1.75 Lt.
Alternator Type : Monophase
Continuous Voltage : 230V
Continuous Freq : 50 Hz.
Continuous Current : 30.4 Amp.
Output : 7 kWA
Max Output : 7,5 kWA
Fuel Consumption : 2.32 - 2.41/h
Size : 865 x 598 x 650mm
Total Weight : 120 - 145 Kg.
Fuel Tank Capacity : 16 Lt.

Field Kitchens with liquid fuel constantly need pressurized air. In order to meet the pressurized air requirement, a generator is supplied with mobile kitchen

Air Compressor

Field Kitchen with liquid fuel constantly need pressurized air. In order to meet the need pressurized air requirement, a compressor is supplied with mobile kitchen.



Model : KYLR-1100
Liter : 125
Bar : 8
Lt. / Min : 327
l / Min : 800
kW / Hp : 1.5 / 2.0
Size : 1350 x 420 x 850mm.
Total Weight : 110 Kg.

Awnings

All mobile kitchens are supplied with instant weather protection tent. Weather protection tent is easy to operate. The swing-up tent gives you ability to cook under waterproof and in more hygienic environment. It also gives protection from rain sun and snow.





Buharlı Kaynatma Kazanı / Boiling Pan with Steam

KOD Code	KAPASİTE Capacity (lt)	EBAT / Size (mm)	Fiyat Price €
99050330005	300,00		FİYAT ALINIZ
99050330006	400,00	Ø 900	FİYAT ALINIZ
99050330007	500,00	Ø 1100	FİYAT ALINIZ

- TR**
- * Paslanmaz çelik sacdan mamul
 - * İç kazan 304 2,5 mm pres baskı formlu
 - * Dış cidar 304 kalite 2,5 mm
 - * Kapak çift cidarlı dışı 304 kalite 1,00 mm ve içi 1,20 mm sacdan pres baskılı özel formlu imal edilip argon kaynak ile kaynatılıp kaynak izleri taşlanmıştır.
 - * Kapak üzerinde yay mekanizması bulunur.
 - * Kapak contalı olup ,pişirme esnasında kilitlemesi için üzerinde 2 adet kilit mekanizması bulunur.
 - * Kapak üzerinde buhar atma ventili bulunur (kapak emniyet valfi)
 - * Kazan üzerinde cidar buhar basınç ventili ve buhar basıncını gösteren manometre bulunur.
 - * Kazan etrafı izolasyon malzemesi (cam yünü) kaplanmış olup, ısı kaybı önlenmiştir.
 - * Kazan etrafı 0,80 mm paslanmaz çelik sac ile kaplanmıştır.
 - * Kazan tabanında profil şase olup, bu şasede 4 adet yüksekliği ayarlanabilir çap 60 mm paslanmaz çelik ayak bulunmaktadır.
 - * Kazan buhar girişi 1,5" dir.
 - * Kazan buhar çıkışı ¾" dir.
 - * Kazan yemek boşaltma vanası 2" kapasiteli olup istem dışı açılmaları karşı emniyet kolludur.
 - * Kazan üst tablasında kazan içine su doldurulması için sıcak-soğuk çift su bağlantılı kuğu tip evye bataryası mevcuttur.
 - * Buharlı kazan cidar basıncı 0,4 bar/40 paskal (max. 0,5 bar) dir.
 - * Buhar tüketimi maksimum 90 kg/h
 - * Kazan gövdesi silindirik formlu olup 400 lt kapasitelidir.

- EN**
- * Made of stainless steel sheet
 - * Internal boiler 304 2,5 mm press form
 - * Outer wall 304 quality 2,5 mm
 - * Cover is double-walled outer 304 quality 1,00 mm and 1.20 mm inner plate is produced with press-printed special form, welded with argon welding and welded with welding marks.
 - * There is a spring mechanism on the cover.
 - * Cover is sealed and there are 2 locking mechanisms on it for locking during cooking.
 - * Steam vent valve on the cover (valve safety valve)
 - * There is a pressure gauge on the boiler and a manometer showing the vapor pressure.
 - * The boiler is covered with insulating material (glass wool) and heat loss is prevented.
 - * The boiler is covered with 0,80 mm stainless steel sheet.
 - * The bottom of the boiler is a profiled chassis, in which there are 4 height adjustable diameter 60 mm stainless steel feet.
 - * Boiler steam inlet is 1.5 ".
 - * Boiler steam output is ¾ ".
 - * The boiler food drain valve is 2 "capacity and the safety lid against unintentional opening.
 - * There is a hot-cold double water connection swan type battery for filling water into the boiler on the boiler top plate.
 - * The steam boiler has a pressure of 0,4 bar / 40 pascals (max 0.5 bar).
 - * Steam consumption maximum 90 kg / h
 - * Boiler cylinder is cylindrical form and has 400 lt capacity.



CONTAINER KITCHEN

KONTEYNER MUTFAK



www.kayalarmutfak.com.tr

info@kayalarmutfak.com.tr



444 5 957

+90 212 859 00 07

DİĞER PROJELERİMİZ

- ENDÜSTRİYEL MUTFAK PROJELERİ
- MOBİL FIRINLAR
- SAHRA MUTFAKLAR
- KIZILAY MEVLANA EVLERİ
- MOBİL EVLER





www.kayalarmutfak.com.tr

 444 59 57





 +90 212 444 59 57

 +90 212 859 00 07

 +90 212 859 00 14

 info@kayalarmutfak.com.tr

 export@kayalarmutfak.com.tr

 pazarlama@kayalarmutfak.com.tr

KAYALAR ÇELİK SAN. VE TİC. A.Ş.

 Türkoba Mah. Kayalar Cad. No:7/1
Büyüçekmece İstanbul TURKEY